

EN CMC-TC Basic CMC
DK 7320.111
Assembly, Installation and Operation



Microsoft Windows is a registered trademark of Microsoft Corporation.
Acrobat Reader is a registered trademark of Adobe Systems Incorporated.

Contents

1	Notes on the documentation	5	7.3.9	Configuring the sending of e-mails ...	20
1.1	Associated documents	5	7.3.10	Configuring Syslog	20
1.2	CE labelling	5	7.3.11	Configuring system name, contact and location	20
1.3	Retention of documents	5	7.3.12	Configuring passwords	20
1.4	Used symbols	5	7.3.13	Changing the HTTP port	21
2	Safety notes	5	7.3.14	HTTPS (SSL) function	21
3	Device description	6	7.3.15	Configuring FTP access	21
3.1	Housing	6	7.3.16	SFTP access	21
3.2	Power supply	6	7.3.17	Configuring the timeout window	21
3.3	Network characteristics	6	7.3.18	Configuring Telnet access	21
3.4	Connectable sensors	7	7.3.19	Activating restart	22
3.5	System prerequisites	7	7.3.20	Configuring connected sensors	22
3.6	Scope of supply	7	7.3.21	General configuration of the Basic CMC	22
3.7	Accessories	8	7.3.22	Configuring SMS notification (GSM unit)	23
3.7.1	Required accessories	8	7.3.23	Configuring SMS notification (ISDN unit)	23
3.7.2	Optional accessories	9	7.3.24	Entering the telephone numbers for SMS notification	23
3.8	Proper usage	9	7.3.25	Calling the Basic CMC information page	23
4	Assembly	10	7.3.26	Resetting all settings in the main menu	23
4.1	Assembly instructions	10	7.3.27	Manual search for sensors	24
4.2	Assembly of the Basic CMC	10	7.4	Transferring files using the serial interface	24
5	Installation	11	7.5	Saving files using the serial interface	24
5.1	Safety and other instructions	11	7.6	Access using a browser	24
5.2	Connecting the power supply	11	7.6.1	Login	24
5.3	Establishing the network connection	11	7.6.2	Main page view	24
5.4	Establishing the sensor connection	12	7.6.3	Main settings	25
5.4.1	Connecting the sensor	12	7.6.4	Configuring the scheduler	25
5.5	Connecting the alarm relay	12	7.6.5	Configuring the GSM unit	26
5.6	Connecting the power expansion unit	12	7.6.6	Configuring the ISDN unit	26
5.7	Connecting the programming interface	13	7.6.7	Configuring the sending of e-mails ...	26
6	Commissioning	14	7.6.8	Viewing the log file	27
7	Operation	16	7.6.9	Administration	27
7.1	Becoming familiar with the menu structure	16	7.7	Configuring the sensors	28
7.2	Operating instructions	17	7.7.1	General overview (status window)	28
7.3	Setting the base configuration	17	7.7.2	Sensor overview	29
7.3.1	Network configuration	17	7.7.3	General overview (sensor configuration)	29
7.3.2	Configuring the trap receiver	17	7.7.4	Configuring the temperature sensor	30
7.3.3	Configuring SNMPv1 access	17	7.7.5	Configuring the humidity sensor	30
7.3.4	Configuring the read/write community	18	7.7.6	Configuring the analogue sensor input module	31
7.3.5	Configuring the authentication traps	18	7.7.7	Configuring the access sensor	32
7.3.6	Changing the SNMP version	18	7.7.8	Configuring the vandalism sensor	32
7.3.7	Configuring NTP	18	7.7.9	Configuring the air flow sensor	33
7.3.8	Configuring PPP	19			

1 Notes on the documentation

EN

7.7.10	Configuring the smoke detector	33
7.7.11	Configuring the motion sensor	34
7.7.12	Configuring the digital input module..	34
7.7.13	Configuring the digital relay output module.....	35
7.7.14	Configuring the switching combinations for the digital relay output module	36
7.7.15	Configuring the voltage monitor	36
7.7.16	Configuring the voltage monitoring for the voltage monitor with IEC switching output	37
7.7.17	Configuring the switching output for the voltage monitor with IEC switching output	37
7.7.18	Configuring the switching combinations for the voltage monitor with IEC switching output.....	38
7.7.19	Configuring the voltage monitoring for the voltage monitor with 16 A switching output	38
7.7.20	Configuring the switching output for the voltage monitor with 16 A switching output	39
7.7.21	Configuring the switching combinations for the voltage monitor with 16 A switching output.....	40
7.7.22	Configuring the 48 V voltage monitor	40
7.7.23	Configuring the leak sensor	40
7.7.24	Configuring the acoustic sensor.....	41
7.8	Access using Telnet	42
7.8.1	Login using Telnet.....	42
7.8.2	Telnet main menu.....	42
7.9	Perform a software update.....	42
7.10	Error messages	42
7.11	Structural layout of the MIB of the Basic CMC	43
7.12	Saving and transferring the configuration files	44
8	Maintenance and cleaning	45
8.1.1	Cleaning	45
9	Storage and disposal	45
9.1.1	Storage.....	45
9.1.2	Disposal.....	45
10	Customer service	45
11	Technical specifications	46
12	Technical terms	46
13	Declaration of conformity	48

1 Notes on the documentation

This manual is targeted at technical personnel familiar with the assembly, installation and operation of the Basic CMC.

- You must read this operating guide before the commissioning and store it for further use at an accessible location.

Rittal cannot accept any liability for damage and operational faults that result from the non-observance of this manual.

The manual applies to software release as of Version 5.40 of the Basic CMC.

1.1 Associated documents

In conjunction with this manual, the manuals for other CMC-TC components and their safety notes, etc. also apply.

This manual is also available as file on the accompanying CD-ROM:

German: 7320111VXXd.pdf

English: 7320111VXXe.pdf

To view the manual, you require the Acrobat Reader program that can be downloaded from www.adobe.com.

1.2 CE labelling

The conformance declaration is contained in the Appendix.

1.3 Retention of documents

These instructions and all associated documents shall constitute an integral part of the product. They must be supplied to the device operator. The device operator shall be responsible for storage of the documents, to ensure that they are readily available when needed.

1.4 Used symbols

Please observe the following safety instructions and other notes in this guide:

Symbol for an instructed action:

- The bullet point indicates that you should perform an action.

Safety and other instructions:



Danger!
Immediate danger to life and limb!



Warning!
Potential threat to the product and its environment!



Note!
Useful information and special features.

2 Safety notes

- Please observe the following general safety notes for the installation and operation of the unit:
 - The assembly and installation of the Basic CMC, in particular for the cabling of enclosures with mains voltage, may only be made by a specialised electrician. Other tasks in conjunction with the Basic CMC, such as assembly and installation of system components with tested standard plug connections, and the operation and configuration of the Basic CMC, may be performed only by instructed personnel.
 - Observe the valid regulations for the electrical installation for the country in which the device will be installed and operated, and their national regulations for accident prevention. Also observe the company-internal regulations (work, operating and safety regulations).
 - Before commencing work on the CMC-TC system, it must be disconnected from the mains and prevented from being switched on again.
 - Use only original or recommended products and accessories (see Section 3.7 Accessories). The use of other parts can void the liability for any resulting consequences.
 - Do not make any changes to the Basic CMC other than those described in these instructions or associated instructions.
 - The operational safety of the device is guaranteed only when used correctly. The limit values specified in the technical data (see Chapter 11 Technical specifications) may not be exceeded under any circumstances. In particular, this concerns the permitted ambient temperature range and the permitted IP protection category. If used with a higher required IP protection category, the Rittal CMC-TC must be installed in the housing or enclosure with a higher IP protection category.
 - The CMC-TC system must not be operated in direct contact with water, aggressive materials or inflammable gases and vapours.
 - Other than these safety notes, also observe the special safety notes contained in the individual sections for the particular tasks.

3 Device description

3 Device description

The Basic Computer Multi Control (subsequently called Basic CMC) is an "intelligent" enclosure monitoring system. Installed in its own housing on the enclosure, it uses a wide range of connected sensors to perform the complete physical monitoring of the enclosure, i.e. temperature, humidity, vibration, smoke, voltage, etc. All this information is transferred using SNMP to a management station where it can be administered.

The supplied CD-ROM contains software (CMC-TC Manager, as of V 1.5) that can be used to monitor and administer one or more Basic CMCs. The associated current version of the CMC-TC Manager is available at www.rimatrix5.com.

3.1 Housing

The Basic CMC is installed in a dedicated housing that can be fastened to the inner side of the side panel, to the punched sections with mounting flanges or to shelves of the enclosure using supplied Velcro straps. Mounting units (see Section 3.7.1 Required accessories) can also be used to mount the housing.

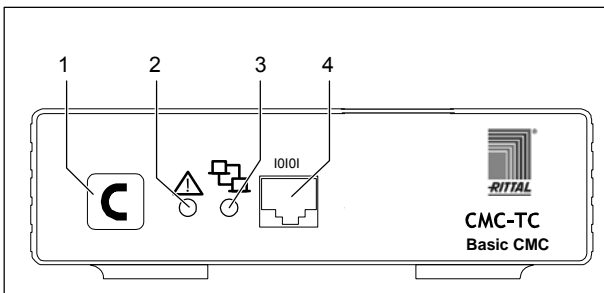

Fig. 1 Basic CMC front side

Key:

- 1 Confirm key (C key)
- 2 Status LED
- 3 Network LED
- 4 Serial interface (RS-232 connection)

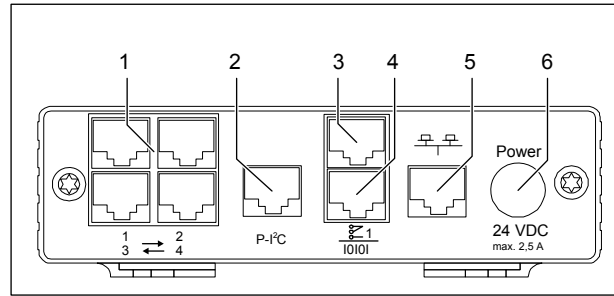

Fig. 2 Basic CMC rear side

Key:

- 1 Sensor connections (1-4)
- 2 P-I²C connection
- 3 Alarm relay output (floating changeover contact)
- 4 Serial interface (IOIOI)
- 5 Network connection
- 6 Power supply connection (Power)

3.2 Power supply

The Basic CMC is supplied with power using an external power pack. The connection cable for the external power pack is available as accessory in various country variants. Select the connection cable as appropriate for the country-specific regulations. A selection of various connection cables is contained in Section 3.7 Accessories.

All connected sensors are supplied with power from the Basic CMC. The Basic CMC has an integrated alarm relay equipped with a floating changeover contact. It is used to provide an optical or acoustic alarm. A connection with a serial interface that can be used for various sensor units and extended units is also available.

3.3 Network characteristics

The Basic CMC provides an Ethernet 10/100BaseT network connection that supports the following protocols:

- RS232 serial interface: e.g. Hyperterminal
- In the Ethernet network: e.g. TELNET
- SNMPv1, compatible with common management systems
- SNMPv3,
- HTTP, HTTPS
- FTP, SFTP
- NTP (Network Time Protocol)
- SSH (Secure Shell)
- SSL 3.0 (Secure Socket Layer)
- DHCP (Dynamic Host Configuration Protocol)
- SMTP

Optionally, the Basic CMC can also communicate using a Master Unit II as of V 2.2 or using an ISDN or GSM unit. Associated information is available at the Rittal homepage (www.rittal.com) or in Cata-

logue 32. Detailed documentation for the GSM and the ISDN unit is also available at www.rimatrix5.com

The network connection is made using a suitable network cable with RJ-45 plug in the existing Ethernet network structure.

The communication is made using a standard browser and so is independent of the operating system.

Any number of Rittal Basic CMCs can be connected in the network, provided sufficient free IP addresses are available in the network. In addition, up to 10 Basic CMCs can be administered from the Rittal CMC-TC Master.

Network protocols are used for the communication (password query, switching commands, status queries and alarms) between the Rittal Basic CMC, the administrators and users in the network (network/internet/intranet).

The SNMP functionality is also independent of the operating system, the network management protocol must, however, support SNMP V1.0 or V3.0. The Basic CMC also supports the Standard MIB II. The private MIB is part of the scope of supply. Further information is contained on the supplied CD-ROM ("Basic CMC II v1_1x.mib"). The associated current version of the MIB is available in the internet at www.rimatrix5.com

The private MIB is required for integration in a building management software. It decodes the transferred trap messages to produce unique messages.

3.4

Connectable sensors

Sensor	Model number
Temperature sensor	DK 7320.500
Humidity sensor	DK 7320.510
Analogue sensor input module "4-20 mA"	DK 7320.520
Access sensor	DK 7320.530
Vandalism sensor	DK 7320.540
Airflow monitor	DK 7320.550
Smoke detector	DK 7320.560
Motion sensor	DK 7320.570
Digital input module	DK 7320.580
Digital relay output module	DK 7320.590
Voltage monitor	DK 7320.600
Voltage monitor with 10 A switching output	DK 7320.610
Voltage monitor with 16 A switching output	DK 7320.611
48 V voltage monitor	DK 7320.620
Leak sensor	DK 7320.630
Leak sensor 15 m	DK 7320.631
Acoustic sensor	DK 7320.640

Tab. 1 Connectable sensors

A maximum of four sensors can be connected to a Basic CMC.

3.5 System prerequisites

- Hardware: PC with serial interface and 10/100 MBit network card.
- Software: Operating system (Linux or Windows), Browser (IE 6.0 or equivalent).

3.6 Scope of supply

The unit is supplied in a packaging unit in a fully assembled state.

- Please check the delivery for completeness.
- Check the packaging carefully for any signs of damage.

3 Device description

EN

Qty.	Description
1	Basic CMC with network interface RJ-45 socket (10/100 BaseT)
2	Self-adhesive Velcro strips 90 x 15 mm
1	CD-ROM with software and operating manual
1	Checklist for the commissioning (German/English)

Tab. 2 Scope of supply

3.7

Accessories

3.7.1 Required accessories

Depending on the country-specific regulations, you require an appropriate connection cable for the power pack of the Basic CMC.

Accessories	Description	Packs of	Required	Model no.
Power supply	Assembly power pack 24 V IEC 100-230 V AC, UL-approval, 3 A SELV	1	Yes, depending on the power supply	7320.425
	Assembly power pack 24 V IEC 48 V DC	1		7320.435
Connection cable for power pack	IEC plug connection cable Country variant (D)	1	Yes, once for the power pack	7200.210
	IEC plug connection cable Country variant (GB)	1		7200.211
	IEC plug connection cable Country variant (F/B)	1		7200.210
	IEC plug connection cable Country variant (CH)	1		7200.213
	IEC plug connection cable Country variant (USA/CDN), UL approval FT1/VW1	1		7200.214
	Extension cable, IEC plug and socket	1		7200.215
Assembly	1 U mounting unit	1	Optional	7320.440
	1 U single mounting unit with strain relief	1		7320.450
Programming cable	Programming cable, D-Sub 9 to RJ 11	1	Yes, max. 1 unit	7200.221

Tab. 3 Required accessories

3.7.2 Optional accessories

Accessories	Max. required number of items	Model no.
CMC-TC GSM unit	1	DK 7320.820
CMC-TC ISDN unit	1	DK 7320.830
RJ12 extension cable; 5.0 m	-	DK 7200.450
RJ12 extension cable; 1.0 m	-	DK 7320.814
Extension cable RJ12; 5.0 m	-	DK 7200.430
Extension cable voltage	2	DK 7200.520

Tab. 4 Optional accessories

3.8 Proper usage

The Rittal Basic CMC is used as an enclosure monitoring system for the monitoring and the administration of various enclosure parameters.

Any use other than that described here shall be deemed improper. Rittal cannot accept any liability for damages associated with failure to observe this manual. Where applicable, the instructions for any accessories used shall also apply.

4 Assembly

EN

4 Assembly

4.1 Assembly instructions

Install the Basic CMC in an enclosure or in a suitable housing system so that it is also protected from external effects. Also take account of the permitted ambient temperature and humidity operational ranges, and the application-related required IP degree of protection (see Chapter 11 on page 46).

4.2 Assembly of the Basic CMC

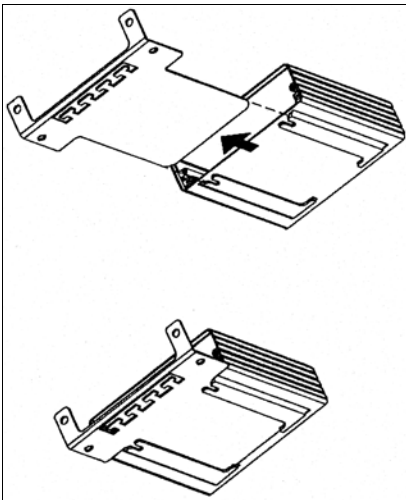

Fig. 3 Assembly with mounting module

- Move the Basic CMC to the retaining plate of the mounting module. Ensure that the retaining plate sits between the guide rails of the Basic CMC.

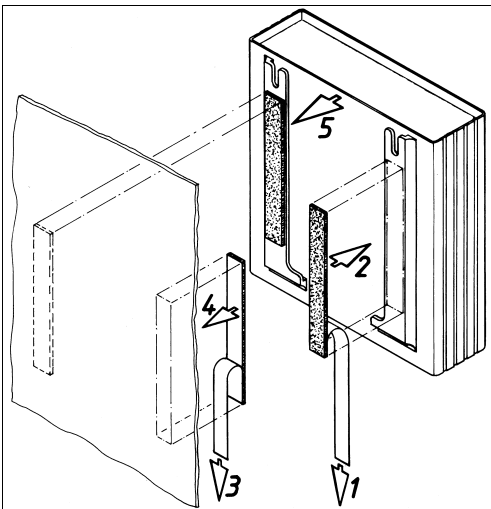

Fig. 4 Assembly with Velcro fasteners

- Take the self-adhesive Velcro fasteners from the supplied equipment and remove the protective foil from the Velcro fasteners.
- Ensure that the adhesive surfaces are free of grease and dust.
- Attach the Velcro fasteners to the Basic CMC housing and position the Basic CMC at the required mounting location.

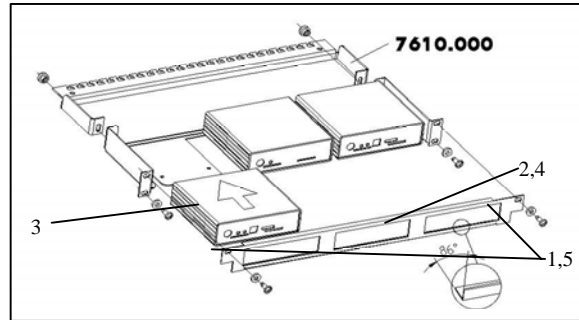

Fig. 5 Assembly with the 1 U mounting unit

1. Remove the upper two screws from the trim panel.
2. Remove the trim panel.
3. Move the Basic CMC to the retaining plate of the mounting unit. Ensure that the retaining plate sits between the guide rails of the Basic CMC.
4. Replace the trim panel on the mounting unit.
5. Screw the trim panel back on the 1 U mounting unit.

5 Installation



Danger!
Assembly and installation may only be performed by properly trained specialists.

5.1 Safety and other notes

- The Rittal Basic CMC may only be operated with connected protective conductor. The protective conductor connection is made by inserting the IEC connection cable. This requires that the IEC connection cable is connected with the protective conductor at the mains side.
- The electrical connection voltage and frequency must match the rated values shown on the housing rear side or in the technical data (see page 46).
- Before commencing work on the Rittal Basic CMC, it must be disconnected from the mains and prevented from being switched on again.
- Attach the connection cables to the used housing or enclosure using cable ties.
- To prevent losses caused by unnecessary cable, the used cable lengths may not exceed the lengths specified in the technical data (see Chapter 11 on page 46).

5.2 Connecting the power supply

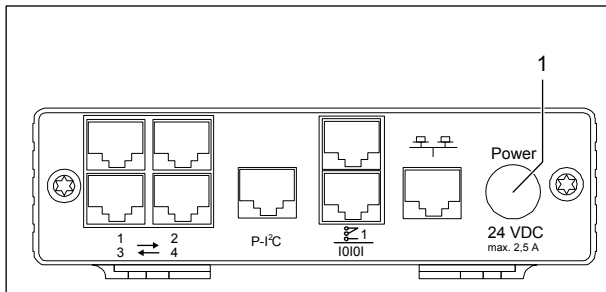

Fig. 6 Connecting the power supply

Key:

- 1 Power supply connection

You must connect the Basic CMC to the power supply using the power packs specified in Section 3.7.1 Required accessories.

- Insert the power pack plug in the "Power" socket of the Basic CMC. Ensure that the ⬆ marking arrow points to the "Power" socket designation.

The plug latches itself. After connecting the power supply, the Basic CMC automatically starts the boot process that lasts approximately three minutes. The Alarm LED illuminates green when the boot process has completed.

To remove the connection plug, draw back the movable ring on the plug and remove the complete plug from the socket.

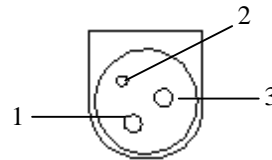

Fig. 7 Pin assignment (plug, viewed from the front)

Key:

- 1 Pin 1: Gnd
- 2 Pin 2: not assigned
- 3 Pin 3: +24V

5.3 Establishing the network connection

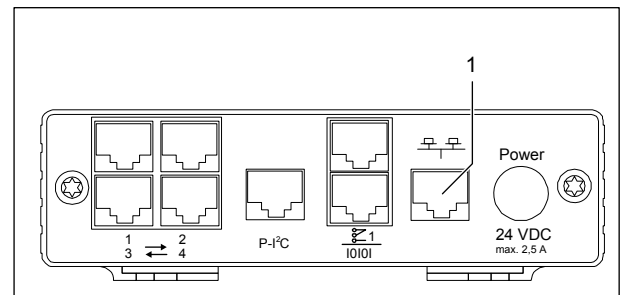

Fig. 8 Establishing the network connection

Key:

- 1 Network connection
- Use the RJ45 network cable to connect the Basic CMC with the existing Ethernet network structure.

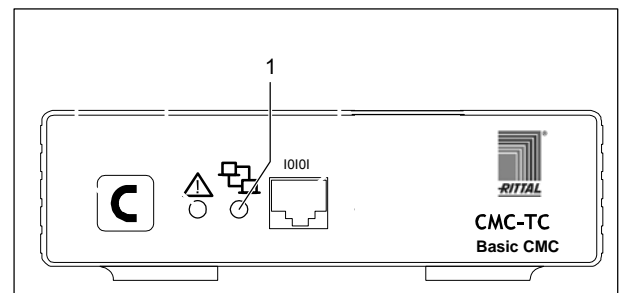

Fig. 9 Checking the network connection

Key:

- 1 Network LED

The network connection exists when the Link LED illuminates green or orange. The Link LED on the front side also begins to flash when data is being exchanged over the network:

Flash green: 10 Mbit transfer

Flash orange: 100 Mbit transfer

5.4

5 Installation

Establishing the sensor connection

5.4.1 Connecting the sensor

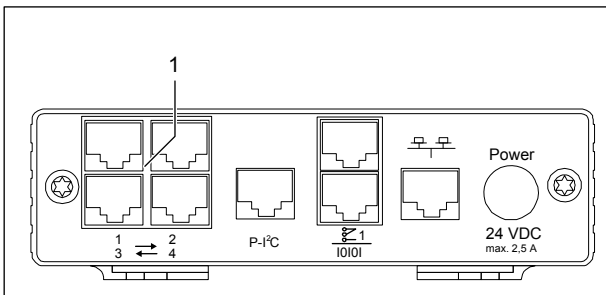

Fig. 10 Establishing the sensor connection

Key:

- 1 Sensor connections (1-4)
- Insert the connection plug of the sensors in any of the four connections (max. four sensors).

The Basic CMC detects automatically the connected sensors.

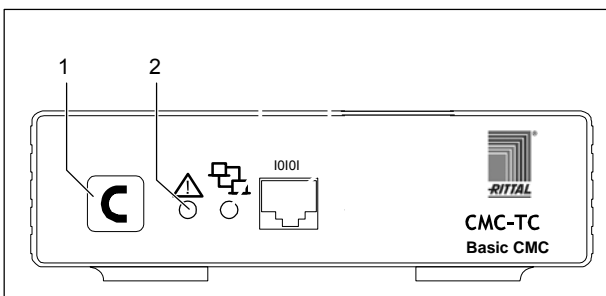

Fig. 11 Checking the sensor connection

Key:

- 1 Confirm key (C key)
- 2 Status LED

Once the sensors have been connected and detected, an acoustic signal sounds and the Status LED of the connection flashes orange.

- Press the C button to confirm the connection of the sensor.

The acoustic signal ends and the Status LED changes from orange to green.

The Basic CMC continually polls the ports of the sensors. Configuration changes that affect sensors will be detected and signalled automatically. The acoustic signal and the Status LEDs indicate such a change.

5.5

Connecting the alarm relay

The alarm relay is connected using the floating changeover contact.



Caution!
Damage danger!
Observe the technical specification of the alarm relay contained in the technical data. The non-observance can damage the alarm relay.

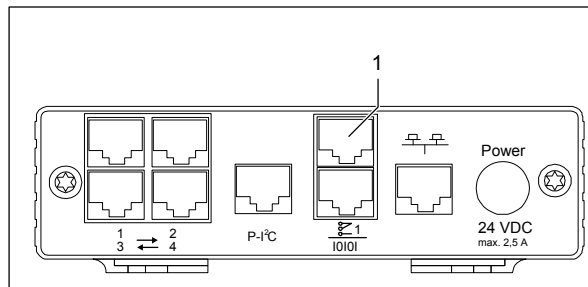

Fig. 12 Connecting the alarm relay

Key:

- 1 Alarm relay output (floating changeover contact)
- Connect the alarm relay at the RJ-12 sockets using an RJ-12 plug.

After the alarm relay has been connected, it must be configured using software (see 7.3.21 General configuration of the Basic CMC). Details for the internal circuitry of the alarm relay are shown below:

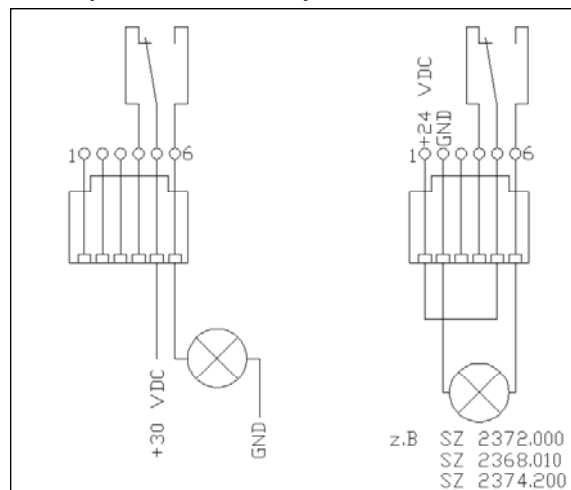

Fig. 13 Power circuit of the alarm relay

5.6 Connecting the extension unit

You can use the P-I²C connection (RJ 45 socket) to connect a maximum of two extension units (3-phases, DK 7200.520) to the Basic CMC. Further details are contained in the operating guide of the extension unit.

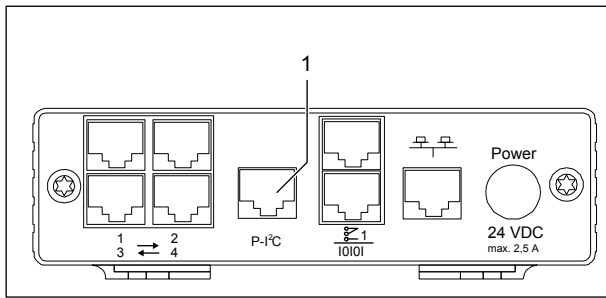

Fig. 14 P-I²C connection

Key:

- 1 Extension unit connection (P-I²C connection)
- Use the DIP switch at the extension unit as follows to address the extension unit:

Switch setting	Addressing
DIP switch at 1	First connected extension unit
DIP switch at 2	Second connected extension unit

Tab. 5 Addressing

- Use an RJ45 cable to establish the connection between the extension unit and the P-I²C connection of the Basic CMC.

5.7 Connecting the programming interface

To configure the Basic CMC, for example, using a notebook, you can connect both using the serial interface. The RS-232 interface of the Basic CMC is provided as RJ-10 front socket.

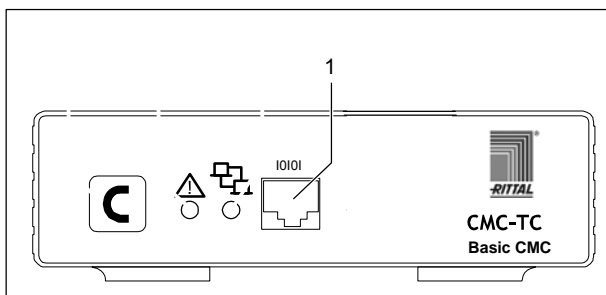

Fig. 15 RS-232 connection

Key:

- 1 Serial interface (RS-232 connection as RJ-10 front socket)
- Connect the programming cable (DK 7200.221) with the RJ-10 front socket and the serial interface of your PC.

6 Commissioning

EN

6 Commissioning

Once you have assembled the Basic CMC and installed all connections, you must now configure the Basic CMC. You can do this using the serial interface (see 5.7 Connecting the programming interface), the network connection with an internet browser (see 7.6 Access using a browser) or Telnet (see 7.8 Access using Telnet).

You must first establish the connection to the Basic CMC. This is shown below using the HyperTerminal program, part of the Microsoft Windows 2000 operating system, as example. The procedure for other operating systems is similar.

To start HyperTerminal, click <Programs> - <Accessories> - <Communication> - <HyperTerminal>.

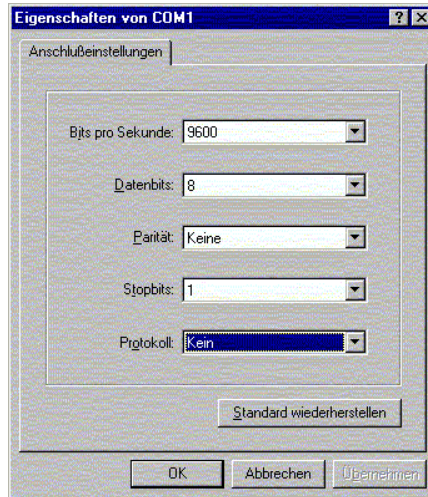

Fig. 18 COM port properties

- Enter the following parameters:
Transmission rate: 9600 bits per second
Data bits: 8
Parity: None
Stop bits: 1
Protocol: None

The standard level range must be observed for the RS-232 interface, otherwise it is possible that the data will be transferred incorrectly.

The HyperTerminal login window appears.



Fig. 16 Enter a name and select a connection

- Enter name.
- Assign the icon for the connection.

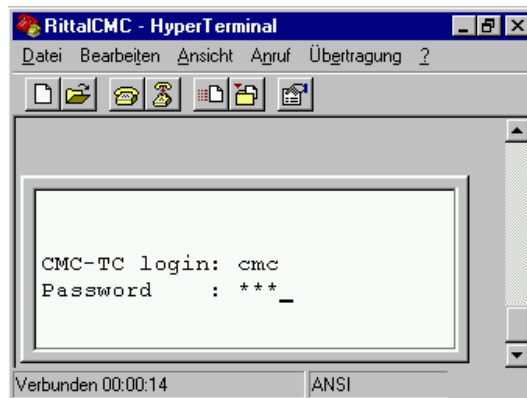

Fig. 19 Login

You must enter your login name (CMC-TC login) and your password here. The default factory setting for both is "cmc".

- You must enter your login name (CMC-TC login) and your password.

You can change your password later (see 7.3.12 Configuring passwords).



Fig. 17 Build connection

- Select the connection using COM port.
- Click "OK".

The properties of the selected COM port are requested once.

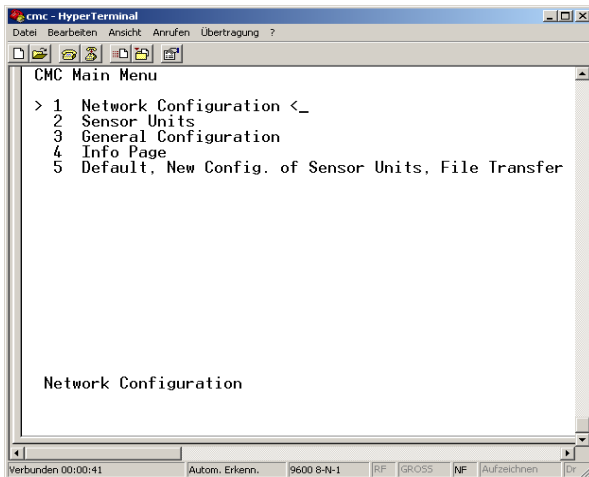

Fig. 20 HyperTerminal start window

If you have been able to establish the connection to the Basic CMC, the HyperTerminal configuration window appears with the configuration menu of the Basic CMC.

You can now make the settings of the Basic CMC appropriate for your local conditions.

7 Operation

EN

7 Operation

7.1 Becoming familiar with the menu structure

The menu structure of the terminal program has the following form:

1 Network Configuration	
1.1 IP Configuration	1.4.2 IP Addr. CMC (DialIn)
1.1.1 IP Address	1.4.3 IP Addr. Client (DialIn)
1.1.2 IP Subnet Mask	1.4.4 Username (DialIn)
1.1.3 IP Def. Gateway	1.4.5 Password (DialIn)
1.1.4 Enable/Disable DHCP	1.4.6 Callback No. (DialIn)
1.1.5 Ethernet Port Settings	1.4.7 Enable PPP (Dialout)
1.2 SNMP Configuration	1.4.8 IP Addr. CMC (Dialout)
1.2.1 Trap Receiver Configuration	1.4.9 IP Addr. Client (Dialout)
1.2.1.1 IP Trap Receiver	1.4.A Username (Dialout)
1.2.1.2 Enable/Disable	1.4.B Password (Dialout)
1.2.1.3 IP Trap Receiver	1.4.C Phone Number (Dialout)
1.2.1.4 Enable/Disable	1.4.D Modem Type
1.2.1.5 IP Trap Receiver	1.4.E MSN (for ISDN)
1.2.1.6 Enable/Disable	1.4.F Modem Baudrate
1.2.1.7 IP Trap Receiver	1.5 SMTP (eMail) Configuration
1.2.1.8 Enable/Disable	1.5.1 IP Addr. SMTP Server
1.2.2 SNMPv1 IP Access	1.5.2 SMTP Server Authentication
1.2.2.1 SNMPv1 Manager	1.5.3 SMTP Server Username
1.2.2.2 SNMPv1 Manager	1.5.4 SMTP Server Password
1.2.2.3 SNMPv1 Manager	1.5.5 eMail Sender Name
1.2.2.4 SNMPv1 Manager	1.5.6 eMail Reply to
1.2.2.5 SNMPv1 Manager	1.5.7 eMail upon Unit Messages
1.2.2.6 SNMPv1 Manager	1.5.8 eMail Address
1.2.2.7 SNMPv1 Manager	1.5.8.1 eMail Address
1.2.2.8 SNMPv1 Manager	1.5.8.2 eMail Address
1.2.2.9 SNMPv1 Manager	1.5.8.3 eMail Address
1.2.2.A SNMPv1 Manager	1.5.8.4 eMail Address
1.2.2.B SNMPv1 Manager	1.6 Syslog Configuration
1.2.2.C SNMPv1 Manager	1.6.1 IP Addr. Syslog Server
1.2.3 Read Community	1.6.2 IP Addr. Syslog Server
1.2.4 Write Community	1.6.3 Syslog Facility
1.2.5 Enable Auth. Traps	1.6.4 Enable Syslog
1.2.6 Change SNMP Version	1.7 System Name
1.2.7 Default SNMPv3 User Name	1.8 System Contact
1.2.8 Default SNMPv3 Password	1.9 System Location
1.2.9 Confirm SNMPv3 user/Passw	

1.3 NTP Configuration	1.A Security
1.3.1 Enable NTP	1.A.1 Change Password User 'cmc'
1.3.2 IP Addr. NTP Server 1	1.A.2 Change Password User 'admin'
1.3.3 IP Addr. NTP Server 2	1.A.3 Change HTTP Port
1.3.4 NTP Offset to UTC	1.A.4 Enable SSL
1.3.5 NTP Update Frequency (h)	1.A.5 Change HTTPs Port
1.3.6 Dayl. Saving Time, Begin	1.B Enable FTP
1.3.7 Dayl. Saving Time, End	1.C Cons./Teln. Timeout Minutes
1.4 PPP Configuration	1.D Enable/Disable Telnet
1.4.1 Enable PPP (DialIn)	1.E Activate Actual Values
2 Sensors	
2.1 Sensors	2.1.1.C Trap Receiver 4/Log
2.1.1 e.g. Temperature Sensor	2.1.1.D Alarm Reset
2.1.1.1 Status	2.1.1.E Send SMS
2.1.1.2 Value	2.1.1.F Send eMail
2.1.1.3 High Setpoint	2.1.2 e.g. Humidity Sensor
2.1.1.4 Warning Setpoint	2.1.3 not available
2.1.1.5 Low Setpoint	2.1.4 not available
2.1.1.6 Message Text	2.1.5 Sensor Unit Name
2.1.1.7 Alarm Relay	2.1.4 Status of Unit
2.1.1.8 Beeper	2.2 Unit 2 not available
2.1.1.9 Trap Receiver 1	2.3 Unit 3 not available
2.1.1.A Trap Receiver 2	2.4 Unit 4 not available
2.1.1.B Trap Receiver 3	
3 General Configuration	
3.1 Temperature Unit	3.9.2 SMS Service Number
3.2 Beeper	3.9.3 ISDN MSN
3.3 Quit Alarm Relay	3.9.4 ISDN Pre-Dial Number
3.4 Alarm Relay Options	3.9.5 ISDN Command
3.5 Web Access	3.9.6 SMS upon Unit Message
3.6 Actual Date	3.9.7 SMS Phone Numbers
3.7 Actual Time	3.9.7.1 SMS Phone Number
3.8 Check Link	3.9.7.2 SMS Phone Number
3.9 SMS Configuration	3.9.7.3 SMS Phone Number
3.9.1 GSM Card PIN	3.9.7.4 SMS Phone Number
4 Info Page	
5 Default, New Config. Of Sensor Units, File Transfer	
5.1 Set General Configuration to Default	5.3.1 Send File to CMC
5.2 Sensor Unit Detection	5.3.2 Receive File from CMC
5.3 Serial File Transfer (ZModem)	

Fig. 21 Menu structure

7.2 Operating notes

The following sections list all configuration parameters of the Basic CMC as tables. The basic operation is always the same:

- Use the "up" ↑ and "down" ↓ arrow keys to navigate within the menu structure.
- Use the "left" ← and "right" → arrow keys to scroll within fields that have several default values.
- Enter from the keyboard any required data in fields for text or numeric information.
- The "Esc" key can be used to cancel your inputs.
- Press "Return" or "Enter" to confirm all inputs.

7.3 Setting the base configuration

You only need to set the network configuration, the alarm relay and the trap receiver for the base configuration. You can make further settings from a browser or using Telnet.

7.3.1 Network configuration

You can use this menu to change your network settings.

Navigation	
Main menu – 1 Network Configuration – 1 IP Configuration	
Parameter	Explanation
IP Address	Enter your IP address (factory setting 192.168.0.190).
IP Subnet Mask	Enter your IP subnet mask address (factory setting 255.255.255.0).
IP Def. Gateway	Enter the IP for the router (factory setting 0.0.0.0).
Enable/Disable DHCP	Set whether the Basic CMC is to obtain the IP address automatically: Enable or disable the function.
Ethernet Port Settings	Configure the network interface of the Basic CMC on your network. Possible settings: Auto, 100/Half, 100/Full, 10/Half, 10/Full

A restart must be performed to save the settings:

Navigation	
Main menu – 1 Network Configuration – D Activate Actual Values	
Parameter	Explanation
Activate Actual Values	Activate new values: Select "Yes" and press the Return key to perform a restart.

If DHCP is enabled, a connection to a DHCP server present in the network will be established during the restart and an IP address obtained from it. If no IP address can be obtained from the DHCP server, the last valid IP address or default address will be used. A restart is also required for disabling DHCP.

7.3.2 Configuring the trap receiver

To obtain messages and notifications, so-called trap messages, of the Basic CMC, the IP address of the console on which the management software package (e.g. HP OpenView) is installed, must be entered. The management software must support the SNMP protocol.

Navigation	
Main menu – 1 Network Configuration – 2 SNMP Configuration – 1 Trap Receiver Configuration	
Parameter	Explanation
IP Trap Receiver	Enter the IP address of the messages recipient (factory setting 0.0.0.0).
Enable/Disable	Enable or disable the receiving at the receiver located above.

Enter any other required receivers (maximum four) in the lines available below.

7.3.3 Configuring SNMPv1 access

Management software that supports SNMP (e.g. HP OpenView or CMC-TC Manager V 1.5) can access the Basic CMC from the network. To restrict access, you can permit access for specified IP addresses (max. 12). Access is then blocked for all other IP addresses that have not been entered. If no IP address has been entered, any management software in the network has access to the Basic CMC.

Navigation	
Main menu – 1 Network Configuration – 2 SNMPv1 IP Access	
Parameter	Explanation
SNMPv1 Manager	Set the IP address for the PC with the SNMP management software that may access the Basic CMC.

7.3.4 Configuring the read/write community

To make the settings for a management software on the Basic CMC, you must set the community of the Basic CMC and the management software.

Navigation	
Main menu – 1 Network Configuration – 2 SNMP Configuration – 3 Read Community / 4 Write Community	
Parameter	Explanation
3 Read Community	Set the Read Community for the trap handling. Press the Backspace key to clear the factory setting and enter the new name.
4 Write Community	Set the Write Community for the trap handling. Press the Backspace key to clear the factory setting and enter the new name.

7.3.5 Configuring the authentication traps

For an SNMP query (read or write) to the Basic CMC with invalid Read/Write Community, the Basic CMC will send an authentication trap to all enabled trap receivers.

Navigation	
Main menu – 1 Network Configuration – 2 SNMP Configuration – 5 Enable Auth. Traps	
Parameter	Explanation
Enable Auth. Traps	Use the ← and → arrow keys to enable or disable FTP.

7.3.6 Changing the SNMP version

As of software version 2.45, the Basic CMC supports two types of SNMP. SNMPv1 and SNMPv3 are available. SNMPv3 provides more security than SNMPv1. An authentication is required for SNMPv3.

Navigation	
Main menu – 1 Network Configuration – 2 SNMP Configuration	
Parameter	Explanation
6 Change SNMP Version	Use the ← and → arrow keys to set the SNMPv1 and SNMPv3.
7 Default SNMPv3 User Name	Set the username for 'cmc' SNMPv3 access (max. 20 characters). Press the Backspace key to clear the factory setting and enter the new username.
8 Default SNMPv3 Password	Set the password for 'cmc' SNMPv3 access (max. 20 characters). Press the Backspace key to clear the factory setting and enter the new password.
Confirm SNMPv3 user/Passw	Use the ← and → arrow keys to confirm the SNMPv3 authentication.

7.3.7 Configuring NTP

The Network Time Protocol (NTP) is a standard for the time synchronisation of the internal clock over the network.

The NTP function synchronises the local, internal clock of the Basic CMC using external time signals obtained from an NTP server. To use this function in the Basic CMC, the network connection to an NTP server must be possible. The IP addresses for two NTP servers (primary and secondary server) can be entered. The time information from the NTP server uses the coordinated world time (UTC) as reference time. The times in the various time zones of the world are derived from this time. For this reason, the current time zone must be set in the Basic CMC menu. The current date and the current time are then represented with the current value taking account of the time zone and the daylight saving setting. Because the begin and end of the daylight saving period differ in the various time zones, these two values can also be set in the Basic CMC.

Navigation	
Main menu – 1 Network Configuration – 3 NTP Configuration	
Parameter	Explanation
1 Enable NTP	Use the ← and → arrow keys to enable or disable NTP.
2 IP Addr. NTP Server 1	Set the first IP address of the NTP server. Press the Backspace key to clear the factory setting and enter the IP address of the first NTP server.
3 IP Addr. NTP Server 2	Set the second IP address of the NTP server. Press the Backspace key to clear the factory setting and enter the IP address of the second NTP server.
4 NTP Offset to UTC	Use the ← and → arrow keys to set your country's time zone.
5 NTP Update Frequency (h)	Set the interval how often the Basic CMC should query the NTP server for the current date and clock time. The values must be entered in hours. Press the Backspace key to clear the factory setting and enter the interval time.
6 Dayl. Saving Time, Begin	Enter the begin of the daylight saving period. Press the Backspace key to clear the factory setting and enter the new entry in the following format: m = month (1...12) n = week of the month (1 = first week, 5 = last week of the month) d = day (0 = Sunday, 6 = Saturday)
7 Dayl. Saving Time, End	Enter the end of the daylight saving period. Press the Backspace key to clear the factory setting and enter the new entry in the following format: m = month (1...12) n = week of the month (1 = first week, 5 = last week of the month) d = day (0 = Sunday, 6 = Saturday)

7.3.8 Configuring PPP

You can administer the Basic CMC from a remote location using an analogue modem. To do this, connect the modem to the serial interface of the Basic CMC.

Navigation	
Main menu – 1 Network Configuration – 4 PPP Configuration	
Parameter	Explanation
1 Enable PPP (DialIn)	Use the ← and → arrow keys to enable or disable PPP.
2 IP Addr. CMC (DialIn)	Set the IP address of the Basic CMCs to establish a connection from a client to the Basic CMC.
3 IP Addr. Client (DialIn)	Set the IP address of the client to dial-in to the Basic CMC.
4 Username (DialIn)	Set an arbitrary username used for login to the Basic CMC (max. 20 characters).
5 Password (DialIn)	Set an arbitrary username for password used for login to the Basic CMC (max. 20 characters).
6 Callback No. (DialIn)	Enter the telephone number to which the Basic CMC should call back.
7 Enable PPP (Dialout)	Use the ← and → arrow keys to enable or disable PPP.
8 IP Addr. CMC (Dialout)	Enter the IP address of the Basic CMC for dial-in to the client.
9 IP Addr. Client (Dialout)	Enter the IP address of the client for dial-in to the client.
A Username (Dialout)	Enter a username as authentication on the client. Note: The username must be entered as user account in the client (max. 20 characters).
B Password (Dialout)	Enter the password used as authentication on the client. Note: The password must be identical with the password of the user account (max. 20 characters).
C Phone Number (Dialout)	Enter the telephone number to which the Basic CMC should call in order to send a trap.
D Modem Type	Select the modem type Analogue, ISDN, GSM (note when a GSM unit is used as modem, the SIM card may not have any

7 Operation

EN

	PIN number).
E MSN (for ISDN)	When an ISDN modem is used, the MSN number must be entered.
F Modem Baud Rate	The bit rate used by the serial interface to communicate with the external modem (for an analogue modem).

2 IP Addr. Syslog Server	Syslog Server 2 to which all alarm and event logs are sent.
3 Syslog Facility	Specifies the origin of the log message (Local0..Local7). Serves as differentiation when several systems are used.
4 Enable Syslog	Enables or disables the Syslog function. The default value is "disabled".

7.3.9 Configuring the sending of e-mails

As of software version 5.40, the Basic CMC can send alarm messages as e-mail using an SMTP server.

Navigation	
Main menu – 1 Network Configuration – 5 SMTP (eMail) Configuration	
Parameter	Explanation
1 IP Addr. SMTP Server	Enter the IP address of the SMTP server.
2 SMTP Server Authentication	Use the ← and → arrow keys for an authentication (Yes) or (No) on the SMTP server.
3 SMTP Server Username	Enter the username for the SMTP server.
4 SMTP Server Password	Enter the password for the SMTP server.
5 eMail Sender Name	Enter the sender address of the Basic CMC.
6 eMail Reply to	When a user answers this alarm message, the response mail will be sent to the entered address.
7 eMail upon Unit Messages	For a timeout, etc. on a unit, an e-mail can be sent as notification. Use the ← and → arrow keys to set "Yes" or "No".
8 eMail Address	Enter up to four different e-mail addresses.

7.3.11 Configuring system name, contact and location

A unique name, a contact address (e-mail) and an installation location can be entered for the Basic CMC.

Navigation	
Main menu – 1 Network Configuration	
Parameter	Explanation
6 System Name	An arbitrary name can be assigned for the Basic CMC. Press the Backspace key to clear the factory setting and enter the new name.
7 System Contact	Set the contact address (e.g. xyz@rittal.de). Press the Backspace key to clear the factory setting and enter the new contact address.
8 System Location	Enter the name of the installation location. Press the Backspace key to clear the factory setting and enter the new installation location.

7.3.12 Configuring passwords

You can change the passwords of the Basic CMC as required. The string length must not exceed 20 characters. Special characters are not permitted.

Navigation	
Main menu – 1 Network Configuration – 9 Security	
Parameter	Explanation
1 Change Password User 'cmc'	Set the password for the 'cmc' user (max. 20 characters). Press the Backspace key to clear the factory setting and enter the new password. To verify the new password, it must be re-entered a second

7.3.10 Configuring Syslog

Navigation	
Main menu – 1 Network Configuration – 6 Syslog Configuration	
Parameter	Explanation
1 IP Addr. Syslog Server	Syslog Server 1 to which all alarm and event logs are sent.

	time.
2 Change Password User 'admin'	Set the password for the 'admin' user (max. 20 characters). Press the Backspace key to clear the factory setting and enter the new password. To verify the new password, it must be re-entered a second time.

Navigation	
Main menu – 1 Network Configuration – A Enable FTP	
Parameter	Explanation
A Enable FTP	Use the ← and → arrow keys to enable or disable FTP.

7.3.13 Changing the HTTP port

For some networks, the standard http port is not set to port 80. You can change the port number to meet your needs.

Navigation	
Main menu – 1 Network Configuration – 9 Security	
Parameter	Explanation
3 Change http Port	Set the http port 80-10000 (factory setting: 80). Press the Backspace key to clear the factory setting and enter the new port.

7.3.16 SFTP access

The secure FTP access includes the SSH data encryption. The function is always active and cannot be disabled. SFTP can be used as alternative to FTP.

7.3.17 Configuring the timeout window

The console and Telnet timeout window is used for the automatic logout after the set time. If a user, for example, has not performed any work on the Basic CMC within five minutes, he/she will be logged off automatically.

7.3.14 HTTPS (SSL) function

For security, the Basic CMC supports SSL encryption. This is used for the secure data exchange between the Basic CMC and the workstation.

Navigation	
Main menu – 1 Network Configuration – 9 Security	
Parameter	Explanation
4 Enable SSL	Use the ← and → arrow keys to enable or disable SSL.
5 Change https Port	Set the https port 80-10000 (factory setting: 443). Press the Backspace key to clear the factory setting and enter the new port.

Navigation	
Main menu – 1 Network Configuration – B Cons./Teln. Timeout Minutes	
Parameter	Explanation
B Cons./Teln. Timeout Minutes	Set the Timeout function in minutes. 0 = no timeout 5 = when no changes have been made within the previous five minutes. Press the Backspace key to clear the factory setting and enter the new time.

7.3.18 Configuring Telnet access

When you use Telnet, you have the same administrative rights as for the serial interface. If access is not to be made using Telnet, you can deactivate it.

7.3.15 Configuring FTP access

The FTP access is used exclusively for downloading software updates, log files and configuration files. It can remain deactivated for normal use.

Navigation	
Main menu – 1 Network Configuration – C Enable/Disable Telnet	
Parameter	Explanation
C Enable / Disable Telnet	Use the ← and → arrow keys to enable or disable Telnet.



Note!

In addition to access using Telnet, an encrypted access to the Basic CMC configuration using an SSH client (e.g. Putty) is possible. In contrast to Telnet access, the SSH access cannot be disabled.

7.3.19 Activating restart

You can use this menu item to reboot the Basic CMC after a software crash.

Navigation	
Main menu – 1 Network Configuration – D Activate Actual Values	
Parameter	Explanation
D Activate Actual Values	Use the ← and → arrow keys to perform a restart (Yes) or not (No).

7.3.20 Configuring connected sensors

The sensors can be configured using Hyperterminal. This method of operation is necessary only when the browser setting has been set to view mode.

Navigation	
Main menu – 2 Sensor Units	
Parameter	Explanation
1-4 connected units	Access to the connected units with the installed sensors.

7.3.21 General configuration of the Basic CMC

The main configuration of the Basic CMC is used to parameterise the hardware and the sensor units. You can also parameterise the date and time, temperature unit, alarm relay, etc.

Navigation	
Main menu – 3 General Configuration	
Parameter	Explanation
1 Temperature Unit	Use the ← and → arrow keys to set Celsius or Fahrenheit as unit.
2 Beeper	Use the ← and → arrow keys to set the alarm beeper on or off.
3 Quit Alarm Relay	Use the ← and → arrow keys to set the alarm relay confirmation.

	In case of alarm, the "C" key can be used to reset the alarm relay on the Basic CMC. Disabled = the alarm relay will be reset automatically after an alarm. Enabled = the alarm relay will be reset after an alarm by pressing the "C" key.
4 Alarm Relay Options	Use the ← and → arrow keys to set the alarm relay function. Close = alarm relay contact is closed. Open = alarm relay contact is open. Off = alarm relay is disabled.
5 Web Access	Use the ← and → arrow keys to set the web access. Full = full access. All current values can be displayed and settings changed on the Basic CMC. View = display. Only the current values are displayed. Changes to the settings cannot be made. No = block web access. The Basic CMC can no longer be called from the web.
6 Actual Date	Set the current date. Press the Backspace key to clear the factory setting and enter the current date. Date format: dd.mm.yyyy
7 Actual Time	Set the current time. Press the Backspace key to clear the factory setting and enter the current time. Time format: hh:mm:ss
8 Check Link	The reachability of the individual trap receivers can be tested. Press the Backspace key to clear the factory setting and enter the number of the trap receiver.
9 SMS Configuration	True only for connected ISDN or GSM unit.

7.3.22 Configuring SMS notification (GSM unit)

This function is active only for connected GSM unit.

Navigation	
Main menu – 3 General Configuration – 9 SMS Configuration	
Parameter	Explanation
1 GSM Card PIN	Set the 4-digit PIN number of the GSM card.
2 SMS Service Number	Set the SMS service number. The specified format must be used, e.g. +491710760000
6 SMS upon Unit Messages	A notification SMS can be sent when a timeout, etc., occurs on a unit. Use the ← and → arrow keys to set to "Yes" or "No".

7.3.23 Configuring SMS notification (ISDN unit)

This function is active only for connected GSM unit.

Navigation	
Main menu – 3 General Configuration – 9 SMS Configuration	
Parameter	Explanation
3 ISDN MSN	Set the MSN number of your ISDN connection. The number must be entered in the following format: +49/2772/123456
4 ISDN Pre-Dial Number	Set the telephone number to obtain an external line. This is necessary when the ISDN unit is connected to a telephone system.
5 ISDN Command	Set the SMS command for sending an SMS over the telephone fixed-line network. For example, "8888 ANMELD" for the T-Com network. Or "09003266900" for the Arcor German network.
6 SMS upon Unit Messages	A notification SMS can be sent when a timeout, etc., occurs on a unit. Use the ← and → arrow keys to set to "Yes" or "No".

7.3.24 Entering the telephone numbers for SMS notification

This function is active only for connected ISDN or GSM unit.

Navigation	
Main menu – 3 General Configuration – 9 SMS Configuration – 7 SMS Phone Numbers	
Parameter	Explanation
1 - 4 SMS Phone Number	Set the SMS destination telephone number. For example: +4927725051234

7.3.25 Calling the Basic CMC information page

To display the current information for the Basic CMC, you can display an information page about the Basic CMC. This page displays all settings for the network connection, the software and hardware version, etc.

Navigation	
Main menu – 4 Info Page	
Parameter	Explanation
4 Info Page	The CMC Info Page shows a complete overview of the configuration of the Basic CMC.

7.3.26 Resetting all settings in the main menu

You can reset all your sensor settings. Passwords and network settings will not be reset.

Navigation	
Main menu – 5 Default, New Config. of Sensor Units, File Transfer	
Parameter	Explanation
1 Set General Configuration to Default	Use the ← and → arrow keys to activate (Yes) or not activate (No) the sensor settings.

7 Operation

EN

7.3.27 Manual search for sensors

Under some circumstances, the Basic CMC sensors will not be detected immediately. In this case, you can activate a manual search for the sensors.

Navigation	
Main menu – 5 Default, New Config. of Sensor Units, File Transfer	
Parameter	Explanation
2 Sensor Unit Detection	Use the ← and → arrow keys to activate (Yes) or not activate (No) the sensor detection.

7.4 Transferring files using the serial interface

You can use the serial interface to transfer individual files to the Basic CMC.

Navigation	
Main menu – 5 Default, New Config. of Sensor Units, File Transfer – 3 Serial File Transfer (ZModem)	
Parameter	Explanation
1 Send File to CMC	Use the ← and → arrow keys to start (Yes) or not start (No) the Zmodem.

You will now be requested to specify the path for the file to be transferred. To do this, click "Search" and search for the file.

Select Zmodem as protocol and click "Send". Once the file has been transferred, press the Esc key several times to return to the main menu and to save the setting.

7.5 Saving files using the serial interface

You can save individual Basic CMC files on your PC.

Navigation	
Main menu – 5 Default, New Config. of Sensor Units, File Transfer – 3 Serial File Transfer (ZModem)	
Parameter	Explanation
2 Receive File from CMC	Enter the name of the Basic CMC file that you want to save on your computer.

Now use the Search icon to select a destination folder for the file to be saved. Remove ZModem as receive protocol and click "Receive" to confirm your input.

7.6 Access using a browser

Call your web browser as usual. Enter the IP address of the Basic CMC in the address bar and call the page.

7.6.1 Login

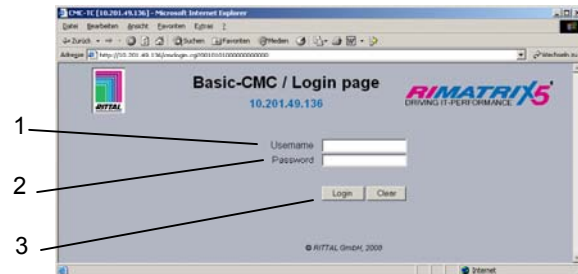

Fig. 22 Login window

Key:

- 1 Username
- 2 Password
- 3 Login or Clear button

In the login window, enter the http user name and the http password of the Basic CMC.

Factory setting:

Username: admin
Password: admin

To confirm the input, click the Login button. To clear the input, click the Clear button.

7.6.2 Main page view

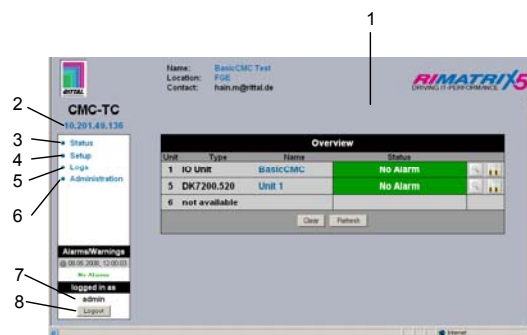





Fig. 23 Main page view

Key:

- 1 Status window
As shown above
- 2 IP address of the Basic CMC
- 3 Link to the main page view
- 4 Setup link
- 5 Alarm and event logging link
- 6 Administration link
- 7 Username
- 8 User logout

The following buttons are provided to simplify the navigation between the individual pages:

-  **Setup button:** Links from the overview page (main or units overview) to the setup pages of the associated unit.
-  **Overview button:** Links from the main overview page to the units overview page.
-  **Back button:** This button can be used to go back one page from any page.
-  **Home button:** Links directly to the main page from any units overview page or from the setup pages.

7.6.3

Main settings

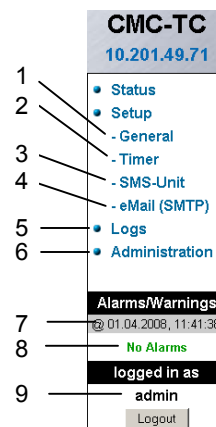

Fig. 24 Main settings

Key:

- 1 General
This link can be used to make fundamental settings on the Basic CMC (name, location, contact name, temperature unit, beeper, alarm relay confirmation, alarm relay options, background colour, date and time).
- 2 Timer function (see 7.6.4 Configuring the scheduler).
- 3 SMS unit (see 7.6.5 GSM Unit or 7.6.6 Configuring ISDN Unit).
- 4 eMail (SMTP).
- 5 Event Logging (see 7.6.8 Viewing the log file).
- 6 Administration linked to the user administration provided you are logged in as administrator. Otherwise you can only change your own password.
- 7 Date and time of the last alarm/warning status change.
- 8 Current status of the alarms and warnings.
- 9 Logged in user.

7.6.4 Configuring the scheduler

You can program a maximum of eight timers.

1. Specify whether the timer is to be active or inactive.
2. Select the day or days on which the timer is to be active.
3. Specify the time window (format: hh:mm).
4. Specify what the timer is to perform during this time.

The following functions can be selected from item 4:

Description	Function
Disable Trap Receiver	No alarms are sent to the trap receiver.
Disable SMS (General)	Deactivates the SMS notification function.
Alarm Scheduler	Deactivates the alarms configured for "Scheduled Alarm off" in the sensor configuration.

7 Operation

EN

Disable SMS Receiver	Deactivates the SMS notification function for a specific recipient.
Disable e-Mail Rec.	Deactivates the e-mail notification function for a specific receiver.
Status e-Mail to Rec.	Sends a status e-mail to a recipient. A maximum of 150 messages are transferred for each status mail. If more than 150 messages are present, only the most recent 150 will be sent in the e-mail.

7.6.5 Configuring the GSM unit

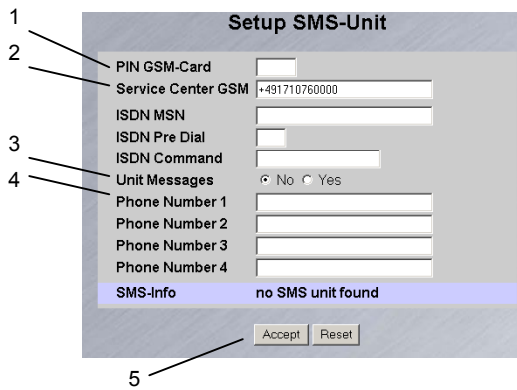

Fig. 25 Setup for SMS unit

Key:

- 1 GSM Card PIN
Enter here the PIN for your GSM card.
- 2 GSM Service Centre
Set the service centre number. This differs depending on the mobile telephone system provider. Observe the notation (e.g. +491710760000).
- 3 Unit Messages
Set whether for a unit error, e.g. timeout or configuration change, an SMS is to be sent.
- 4 Enter the destination telephone numbers (max. four destination telephone numbers, e.g. +4927725051234).
- 5 Accept or Reset button
Accept or reset the settings.

7.6.6 Configuring the ISDN unit

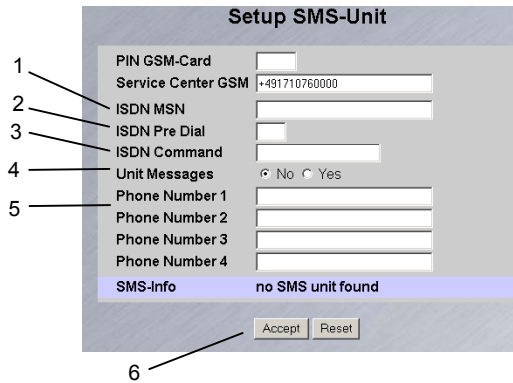

Fig. 26 Setup for ISDN unit

Key:

- 1 ISDN MSN
Enter here the MSN number of the ISDN connection. The MSN number must be entered in the following format: +49/2772/123456
- 2 ISDN Pre Dial
If the ISDN unit is to be connected to a telephone system, you must, for example, enter a "0" to obtain an external line.
- 3 ISDN Command
Specify the SMS command so that an SMS can be sent over the fixed-line network (for example, the following command must be specified for T-Com: "8888 ANMELD").
- 4 Unit Messages
Set whether for a unit error, e.g. timeout or configuration change, an SMS is to be sent.
- 5 Phone Number 1 - 4
Enter here the destination telephone numbers that are to receive an SMS should an alarm occur; the following format must be used: +492772123456.
- 6 Accept or Reset button
Accept or reset the settings.

7.6.7 Configuring the sending of e-mails

If you have not yet used Hyperterminal to enter the e-mail addresses of the alarm recipients, you can do this here. Proceed as follows.

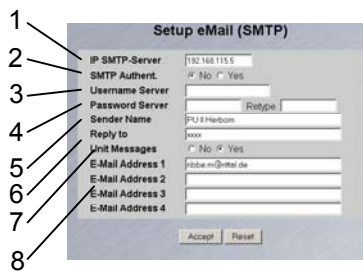

Fig. 27 Setup for sending e-mails

Key:

- 1 SMTP Server IP
Enter here the IP address of the SMTP server.
- 2 SMTP Authent.
If your SMTP server requires a username and password for authentication, click "Yes".
- 3 Server Username
Enter the username for authentication.
- 4 Server Password
Enter the password of the server used for authentication and repeat the input in the Retype field.
- 5 Sender Name
Enter a sender name. This name is then specified as sender in the alarm mail.
- 6 Reply to
If a reply to the alarm mail is required, you can specify an e-mail address to which recipient the response mail is to be forwarded.
- 7 Unit Messages
If the individual units are to display an error message (configuration change, timeout), you can send this alarm as mail. To do this, click "Yes".
- 8 E-Mail Address 1-4
Enter here a maximum of four different e-mail addresses.

Click the "Accept" button to accept and save the settings.

7.6.8 Viewing the log file

Two different types of logging are performed. The first is the "Alarm Log". This displays all alarms that the logged-in user is allowed to view.

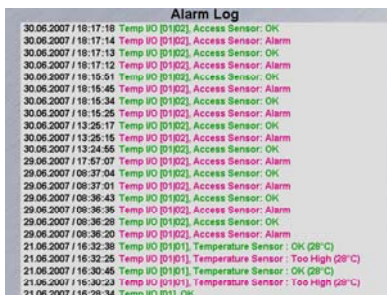

Fig. 28 Alarm Log

The other is the "Event Log". This displays which user logged in and logged out at what time, when an update occurred, when a file was uploaded or downloaded, and various other events.

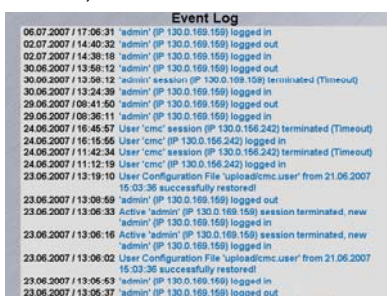

Fig. 29 Event Log

A maximum of 100 messages are recorded. If the memory is full with 100 messages and a new message arrives, the oldest message will be deleted.

7.6.9 Administration

Login as administrator on the login page (see 7.6.1 Login).

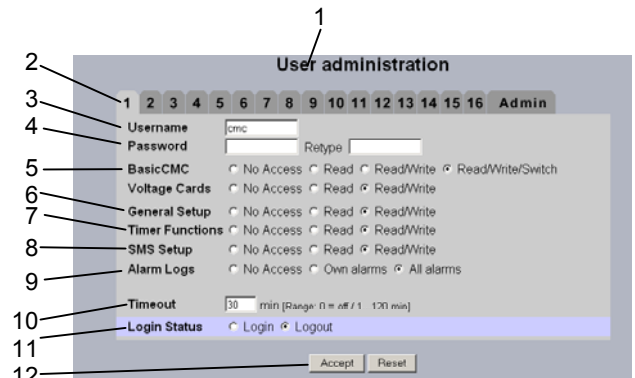

Fig. 30 User administration

Key:

- 1 Page title
- 2 User page
A maximum of 16 different users or user groups can be defined (max. 20 characters; special characters are not permitted).
- 3 Username
Enter the username or group name. Maximum number of characters: 20 characters (special characters are not permitted).
- 4 Password
Password input: Up to 20 characters permitted (special characters are not permitted).
- 5 Basic CMC with 4 sensors / voltage cards
The access rights are defined on the individual units for each user or user group.
No Access: The user has no access to the unit.
Read: The user receives only read rights. Settings cannot be changed.
Read/Write: The user receives read and write rights, and has access to the unit, and can read and change the settings but not switch the unit 1 – 4.
Read/Write/Switch: The user receives read, write and switching rights. Connected power socket strips and digital and analogue inputs/outputs can be used by the user.
- 6 General Setup
No Access: The user has no access to the unit.
Read: The user receives only read rights. Settings cannot be changed.
Read/Write: The user receives read and write rights, and has access to the associated setup web page, and can read and change the settings.
- 7 Timer Functions
No Access: The user has no access to the unit.
Read: The user receives only read rights. Settings cannot be changed.
Read/Write: The user receives read and write rights, and has access to the timer web page, and can read and change the settings.

7 Operation

- 8 SMS Setup
No Access: The user has no access to the SMS Setup web page.
Read: The user receives only read rights. Settings cannot be changed.
Read/Write: The user receives read and write rights, and has access to the web page, and can read and change the settings.
- 9 Alarm Logs
No Access: The user has no access to the Alarm Logging page.
Own alarms: If a user has only access to one or more units, the user will see only the alarm messages of the associated assigned units.
All alarms: The logged in user can view all alarm messages.
- 10 Timeout
If a user does not perform any activity in the browser window for an extended period of time, the user will be logged off from the system after the specified time.
- 11 Login Status
If you are logged in as administrator, you can log off logged-in users.
- 12 Accept/Reset button
Accept button: Settings will be accepted.
Reset button: Settings will not be accepted.

Key:

- 1 Number and type of the I/O unit / Voltage unit.
- 2 Name of the sensor unit: Click to switch to the sensor overview (7.7.2) of the I/O unit.
- 3 Warning or alarm status of the sensor
Green: no warning/alarm
Yellow: warning
Red: alarm (malfunction)
Unit detected: new extension unit has been connected to the Basic CMC
Configuration changed: new sensor has been registered on the Basic CMC or configuration change of a sensor.
- 4 Acknowledge events
Click the Clear button to confirm timeouts and configuration changes. This requeries the Basic CMC and updates the web page.
- 5 Refresh
Forces the immediate update of the Basic CMC web page.
The overview will also be updated automatically every ten seconds.

7.7.2



Note!

If you are logged in as user, you can only change your password in the Administration window.

Logged-in users can only change their own password.

7.7 Configuring the sensors

You can make various settings for each sensor. The Basic CMC has four connections. One sensor can be connected to each connection.

7.7.1 General overview (status window)

Overview			
Unit	Type	Name	Status
1	IO Unit	BasicCMC	No Alarm
5	DK7200.520	Unit 1	No Alarm
6	not available		

Buttons: Clear, Refresh

Callouts: 1 (Unit), 2 (Name), 3 (Status), 4 (Clear), 5 (Refresh)

Fig. 31 I/O units overview

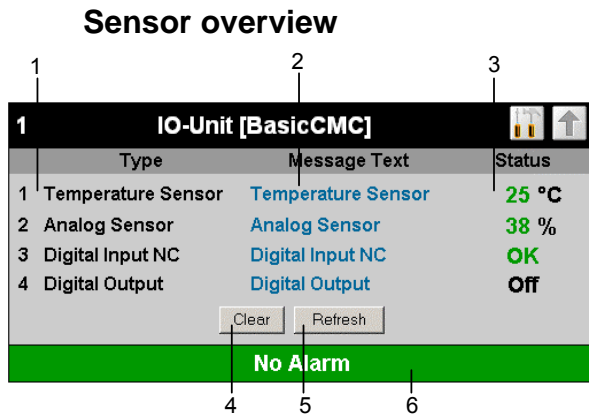

Fig. 32 Sensors overview on the Basic CMC

Key:

- 1 Connection number and sensor type.
- 2 Message text of the sensor. Can be selected freely using the sensor configuration (7.7.3).
- 3 Status or measured value of the sensor. The font colour indicates the status of the sensor. For analogue values, an arrow also indicates the over- or undershooting of the alarm or warning thresholds.
- 4 Acknowledge events
Click the Clear button to confirm timeouts and configuration changes. This requeries the Basic CMC and updates the web page.
- 5 Refresh
Forces the immediate update of the Basic CMC web page. The sensor overview is also updated automatically every ten seconds.
- 6 Warning or alarm status of the sensors (overall)
Green: no warning/alarm
Yellow: warning
Red: alarm (malfunction)

Key:

- 1 Connected sensor type
- 2 Current status of the connected sensor
- 3 This information text will also be transferred when a warning/alarm message is sent; it also serves as information for the recipient of the message to identify the sensor. You can delete the specified text and add your own information text (e.g. TempSensorRack1).
- 7 You can set for each sensor whether (enable) or not (disable) the alarm relay should be switched when an alarm occurs.
- 8 You can set for each sensor whether (enable) or not (disable) the integrated alarm beeper should be activated when an alarm occurs.
- 9 You can set for each sensor type whether after a warning or alarm status the Basic CMC should be acknowledged automatically (Auto) or be acknowledged manually by the administrator (Manual).
- 10 You can click the individual option fields to specify to which of the entered trap receiver the traps for this sensor will be sent.
- 11 Click the individual option fields to set which alarm configuration is to be activated or deactivated. You can specify the individual functions from the "Setup – Timer" menu item and assign the associated schedulers.
- 12 You can enter up to four mobile telephone numbers that you have entered previously from Setup – SMS-Unit; each number is separated with an ampersand "&", e.g. 1&2&3&4.
- 13 You can enter up to four e-mail addresses that you have entered previously from Setup – eMail (SMTP); each address is separated with an ampersand "&", e.g. 1&2&3&4.
- 14 Accept all changes.
- 15 Reset all settings to the default values.

7.7.3 General overview (sensor configuration)

You can individually set the connected sensors. The structure of the configuration overview is generally always identical and shown here as example.

To reach this page, click the message text of the sensor or the tool icon on the general overview (status window) of the Basic CMC.

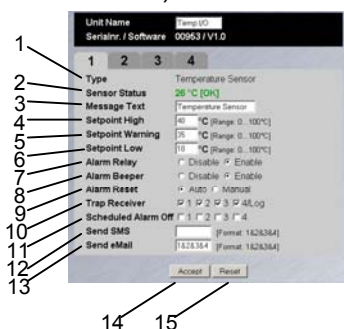

Fig. 33 Configuring sensor – overview Basic CMC

The following buttons are provided to simplify the navigation between the individual pages:



Back button: This button can be used to go back one page from any page.



Home button: Links directly to the main page from any units overview page or from the setup pages.

7 Operation

EN

7.7.4 Configuring the temperature sensor

The temperature sensor (DK 7320.500) is configured as follows:

Navigation	
Main menu – Setup – Click sensor name	
Parameter	Explanation
1 ... n	Connection number of the sensor.
Type	Sensor type. Will be detected automatically.
Sensor Status	Measured temperature and sensor status. Green = OK, yellow = warning, red = alarm
Message Text	Message text also transferred when a warning/alarm message is sent. Enter here a designation that uniquely identifies your sensor, e.g. "TempSensor Rack01".
High Setpoint	Temperature limit which when exceeded causes an alarm message to be issued.
Warning Setpoint	Temperature limit which when exceeded causes a warning message to be issued.
Low Setpoint	Temperature limit which when undershot causes an alarm message to be issued.
Relay Alarm	Whether (enable) or not (disable) a warning/alarm should switch an alarm relay.
Beeper Alarm	Whether (enable) or not (disable) a warning/alarm should cause a signal to be issued.
Reset Alarm	Whether or not a warning/alarm should be acknowledged automatically (Auto) or must be acknowledged by the administrator (Manual).
Trap Receiver	Set to which of the entered trap receivers the warning/alarm messages should be sent. Enter the trap receivers at 7.3.2 Configuring the trap receiver.
Scheduled Alarm Off	Set which alarm configuration should be enabled or disabled. The individual functions can be specified from the "Setup – Timer" menu item.
Send SMS	You can enter up to four mobile

	telephone numbers that you have entered previously from Setup – SMS-Unit; each number is separated with an ampersand "&", e.g. 1&2&3&4.
Send eMail	You can enter up to four e-mail addresses that you have entered previously from Setup – eMail (SMTP); each address is separated with an ampersand "&", e.g. 1&2&3&4.
Accept	Accept the changes.
Reset	Reset all settings to the last-saved values; changes are not accepted.

7.7.5 Configuring the humidity sensor

The humidity sensor (DK 7320.510) is configured as follows: The humidity is specified as relative humidity (% rH).

Navigation	
Main menu – Setup – Click sensor name	
Parameter	Explanation
1 ... n	Connection number of the sensor.
Type	Sensor type. Will be detected automatically.
Sensor Status	Measured humidity and sensor status. Green = OK, yellow = warning, red = alarm
Message Text	Message text also transferred when a warning/alarm message is sent. Enter here a designation that uniquely identifies your sensor, e.g. "Humidity Rack01".
High Setpoint	Humidity limit which when exceeded causes an alarm message to be issued.
Warning Setpoint	Humidity limit which when exceeded causes a warning message to be issued.
Low Setpoint	Humidity limit which when undershot causes an alarm message to be issued.
Relay Alarm	Whether (enable) or not (disable) a warning/alarm should switch an alarm relay.
Beeper Alarm	Whether (enable) or not (disable) a warning/alarm should cause a signal to be issued.

Reset Alarm	Whether or not a warning/alarm should be acknowledged automatically (Auto) or must be acknowledged by the administrator (Manual).
Trap Receiver	Set to which of the entered trap receivers the warning/alarm messages should be sent. Enter the trap receivers at 7.3.2 Configuring the trap receiver.
Scheduled Alarm Off	Set which alarm configuration should be enabled or disabled. The individual functions can be specified from the "Setup – Timer" menu item.
Send SMS	You can enter up to four mobile telephone numbers that you have entered previously from Setup – SMS-Unit; each number is separated with an ampersand "&", e.g. 1&2&3&4.
Send eMail	You can enter up to four e-mail addresses that you have entered previously from Setup – eMail (SMTP); each address is separated with an ampersand "&", e.g. 1&2&3&4.
Accept	Accept the changes.
Reset	Reset all settings to the last-saved values; changes are not accepted.

	tion that uniquely identifies your sensor, e.g. "Analogue sensor Rack1".
High Setpoint	Input current limit which when exceeded causes an alarm message to be issued.
Warning Setpoint	Input current limit which when exceeded causes a warning message to be issued.
Low Setpoint	Input current limit which when undershot causes an alarm message to be issued.
Relay Alarm	Whether (enable) or not (disable) a warning/alarm should switch an alarm relay.
Beeper Alarm	Whether (enable) or not (disable) a warning/alarm should cause a signal to be issued.
Reset Alarm	Whether or not a warning/alarm should be acknowledged automatically (Auto) or must be acknowledged by the administrator (Manual).
Trap Receiver	Set to which of the entered trap receivers the warning/alarm messages should be sent. Enter the trap receivers at 7.3.2 Configuring the trap receiver.
Scheduled Alarm Off	Set which alarm configuration should be enabled or disabled. The individual functions can be specified from the "Setup – Timer" menu item.
Send SMS	You can enter up to four mobile telephone numbers that you have entered previously from Setup – SMS-Unit; each number is separated with an ampersand "&", e.g. 1&2&3&4.
Send eMail	You can enter up to four e-mail addresses that you have entered previously from Setup – eMail (SMTP); each address is separated with an ampersand "&", e.g. 1&2&3&4.
Accept	Accept the changes.
Reset	Reset all settings to the last-saved values; changes are not accepted.

7.7.6 Configuring the analogue sensor input module

The analogue sensor input module (DK 7320.520) is configured as follows: The individual values are specified as percentage.

Navigation	
Main menu – Setup – Click sensor name	
Parameter	Explanation
1 ... n	Connection number of the sensor.
Type	Sensor type. Will be detected automatically.
Sensor Status	Measured input current as percentage and sensor status. Green = OK, yellow = warning, red = alarm
Message Text	Message text also transferred when a warning/alarm message is sent. Enter here a designa-

7 Operation

EN

7.7.7 Configuring the access sensor

The access sensor (DK 7320.530) is configured as follows:

Navigation	
Main menu – Setup – Click sensor name	
Parameter	Explanation
1 ... n	Connection number of the sensor.
Type	Sensor type. Will be detected automatically.
Sensor Status	Access sensor status. Green = OK, red = alarm
Message Text	Message text also transferred when a warning/alarm message is sent. Enter here a designation that uniquely identifies your sensor, e.g. "Access sensor Rack 1".
Relay Alarm	Whether (enable) or not (disable) a warning/alarm should switch an alarm relay.
Beeper Alarm	Whether (enable) or not (disable) a warning/alarm should cause a signal to be issued.
Reset Alarm	Whether or not a warning/alarm should be acknowledged automatically (Auto) or must be acknowledged by the administrator (Manual).
Trap Receiver	Set to which of the entered trap receivers the warning/alarm messages should be sent. Enter the trap receivers at 7.3.2 Configuring the trap receiver.
Scheduled Alarm Off	Set which alarm configuration should be enabled or disabled. The individual functions can be specified from the "Setup – Timer" menu item.
Send SMS	You can enter up to four mobile telephone numbers that you have entered previously from Setup – SMS-Unit; each number is separated with an ampersand "&", e.g. 1&2&3&4.
Send eMail	You can enter up to four e-mail addresses that you have entered previously from Setup – eMail (SMTP); each address is separated with an ampersand "&", e.g. 1&2&3&4.
Accept	Accept the changes.

Reset	Reset all settings to the last-saved values; changes are not accepted.
-------	--

7.7.8 Configuring the vandalism sensor

The vandalism sensor (DK 7320.540) is configured as follows: The individual values are specified as pulses.

Navigation	
Main menu – Setup – Click sensor name	
Parameter	Explanation
1 ... n	Connection number of the sensor.
Type	Sensor type. Will be detected automatically.
Sensor Status	Measured pulses and sensor status. Green = OK, yellow = warning, red = alarm
Message Text	Message text also transferred when a warning/alarm message is sent. Enter here a designation that uniquely identifies your sensor, e.g. "Vandalism Rack 1".
High Setpoint	Pulse limit which when exceeded causes an alarm message to be issued.
Warning Setpoint	Pulse limit which when exceeded causes a warning message to be issued.
Low Setpoint	Pulse limit which when under-shot causes an alarm message to be issued.
Relay Alarm	Whether (enable) or not (disable) a warning/alarm should switch an alarm relay.
Beeper Alarm	Whether (enable) or not (disable) a warning/alarm should cause a signal to be issued.
Reset Alarm	Whether or not a warning/alarm should be acknowledged automatically (Auto) or must be acknowledged by the administrator (Manual).
Trap Receiver	Set to which of the entered trap receivers the warning/alarm messages should be sent. Enter the trap receivers at 7.3.2 Configuring the trap receiver.
Scheduled	Set which alarm configuration

Alarm Off	should be enabled or disabled. The individual functions can be specified from the "Setup – Timer" menu item.
Send SMS	You can enter up to four mobile telephone numbers that you have entered previously from Setup – SMS-Unit; each number is separated with an ampersand "&", e.g. 1&2&3&4.
Send eMail	You can enter up to four e-mail addresses that you have entered previously from Setup – eMail (SMTP); each address is separated with an ampersand "&", e.g. 1&2&3&4.
Accept	Accept the changes.
Reset	Reset all settings to the last-saved values; changes are not accepted.

	should be sent. Enter the trap receivers at 7.3.2 Configuring the trap receiver.
Scheduled Alarm Off	Set which alarm configuration should be enabled or disabled. The individual functions can be specified from the "Setup – Timer" menu item.
Send SMS	You can enter up to four mobile telephone numbers that you have entered previously from Setup – SMS-Unit; each number is separated with an ampersand "&", e.g. 1&2&3&4.
Send eMail	You can enter up to four e-mail addresses that you have entered previously from Setup – eMail (SMTP); each address is separated with an ampersand "&", e.g. 1&2&3&4.
Accept	Accept the changes.
Reset	Reset all settings to the last-saved values; changes are not accepted.

7.7.9 Configuring the air flow sensor

The air flow sensor (DK 7320.550) is configured as follows: Only the status of the sensor is specified.

Navigation	
Main menu – Setup – Click sensor name	
Parameter	Explanation
1 ... n	Connection number of the sensor.
Type	Sensor type. Will be detected automatically.
Sensor Status	Air flow status and sensor status. Green = OK, red = alarm
Message Text	Message text also transferred when an alarm message is sent. Enter here a designation that uniquely identifies your sensor, e.g. "Airflow Rack01".
Relay Alarm	Whether (enable) or not (disable) an alarm should switch an alarm relay.
Beeper Alarm	Whether (enable) or not (disable) an alarm should cause a signal to be issued.
Reset Alarm	Whether or not an alarm should be acknowledged automatically (Auto) or must be acknowledged by the administrator (Manual).
Trap Receiver	Set to which of the entered trap receivers the alarm messages

7.7.10 Configuring the smoke detector

The smoke detector (DK 7320.560) is configured as follows: Only the status of the sensor is specified.

Navigation	
Main menu – Setup – Click sensor name	
Parameter	Explanation
1 ... n	Connection number of the sensor.
Type	Sensor type. Will be detected automatically.
Sensor Status	Smoke detector status and sensor status. Green = OK, red = alarm
Message Text	Message text also transferred when an alarm message is sent. Enter here a designation that uniquely identifies your sensor, e.g. "Smoke detector Rack01".
Relay Alarm	Whether (enable) or not (disable) an alarm should switch an alarm relay.
Beeper Alarm	Whether (enable) or not (disable) an alarm should cause a signal to be issued.

7 Operation

EN

Reset Alarm	Whether or not an alarm should be acknowledged automatically (Auto) or must be acknowledged by the administrator (Manual).
Trap Receiver	Set to which of the entered trap receivers the alarm messages should be sent. Enter the trap receivers at 7.3.2 Configuring the trap receiver.
Scheduled Alarm Off	Set which alarm configuration should be enabled or disabled. The individual functions can be specified from the "Setup – Timer" menu item.
Send SMS	You can enter up to four mobile telephone numbers that you have entered previously from Setup – SMS-Unit; each number is separated with an ampersand "&", e.g. 1&2&3&4.
Send eMail	You can enter up to four e-mail addresses that you have entered previously from Setup – eMail (SMTP); each address is separated with an ampersand "&", e.g. 1&2&3&4.
Accept	Accept the changes.
Reset	Reset all settings to the last-saved values; changes are not accepted.

Relay Alarm	Whether (enable) or not (disable) an alarm should switch an alarm relay.
Beeper Alarm	Whether (enable) or not (disable) an alarm should cause a signal to be issued.
Reset Alarm	Whether or not an alarm should be acknowledged automatically (Auto) or must be acknowledged by the administrator (Manual).
Trap Receiver	Set to which of the entered trap receivers the alarm messages should be sent. Enter the trap receivers at 7.3.2 Configuring the trap receiver.
Scheduled Alarm Off	Set which alarm configuration should be enabled or disabled. The individual functions can be specified from the "Setup – Timer" menu item.
Send SMS	You can enter up to four mobile telephone numbers that you have entered previously from Setup – SMS-Unit; each number is separated with an ampersand "&", e.g. 1&2&3&4.
Send eMail	You can enter up to four e-mail addresses that you have entered previously from Setup – eMail (SMTP); each address is separated with an ampersand "&", e.g. 1&2&3&4.
Accept	Accept the changes.
Reset	Reset all settings to the last-saved values; changes are not accepted.

7.7.11 Configuring the motion sensor

The motion sensor (DK 7320.570) is configured as follows: Only the status of the sensor is specified.

Navigation	
Main menu – Setup – Click sensor name	
Parameter	Explanation
1 ... n	Connection number of the sensor.
Type	Sensor type. Will be detected automatically.
Sensor Status	Motion sensor status and sensor status. Green = OK, red = alarm
Message Text	Message text also transferred when an alarm message is sent. Enter here a designation that uniquely identifies your sensor, e.g. "Motion sensor Rack01".

7.7.12 Configuring the digital input module

The digital input module (DK 7320.580) is configured as follows: Only the status of the sensor is specified.

Navigation	
Main menu – Setup – Click sensor name	
Parameter	Explanation
1 ... n	Connection number of the sensor.
Type	Sensor type. Will be detected automatically.

Sensor Status	Input status and sensor status. Green = OK, red = alarm
Message Text	Message text also transferred when an alarm message is sent. Enter here a designation that uniquely identifies your sensor, e.g. "Dig. input Rack01".
Relay Alarm	Whether (enable) or not (disable) an alarm should switch an alarm relay.
Beeper Alarm	Whether (enable) or not (disable) an alarm should cause a signal to be issued.
Reset Alarm	Whether or not an alarm should be acknowledged automatically (Auto) or must be acknowledged by the administrator (Manual).
Trap Receiver	Set to which of the entered trap receivers the alarm messages should be sent. Enter the trap receivers at 7.3.2 Configuring the trap receiver.
Scheduled Alarm Off	Set which alarm configuration should be enabled or disabled. The individual functions can be specified from the "Setup – Timer" menu item.
Send SMS	You can enter up to four mobile telephone numbers that you have entered previously from Setup – SMS-Unit; each number is separated with an ampersand "&", e.g. 1&2&3&4.
Send eMail	You can enter up to four e-mail addresses that you have entered previously from Setup – eMail (SMTP); each address is separated with an ampersand "&", e.g. 1&2&3&4.
Accept	Accept the changes.
Reset	Reset all settings to the last-saved values; changes are not accepted.

7.7.13

Configuring the digital relay output module

The digital relay output module (DK 7320.590) is configured as follows: Only the status of the sensor is specified.

Navigation	
Main menu – Setup – Click sensor name	
Parameter	Explanation
1 ... n	Connection number of the sensor.
Type	Sensor type. Will be detected automatically.
Output Status	Relay output status; enabled = on, disabled = off
Message Text	Message text also transferred when an alarm message is sent. Enter here a designation that uniquely identifies your sensor, e.g. "Dig. output Rack01".
Delay	Delay time before switching on or off again. 0 s = no initiation time; 999 s = 999 seconds initiation time.
Timeout	Module behaviour in case of failure of the Basic CMC provided the module itself is still supplied with power: stay = after expiration of the time, return to the original state; switch off = after expiration of the time, the output will be switched off; switch on = after expiration of the time, the relay will be switched on.
Trap Receiver	Set to which of the entered trap receivers the status messages should be sent. Enter the trap receivers at 7.3.2 Configuring the trap receiver.
Send SMS	You can enter up to four mobile telephone numbers that you have entered previously from Setup – SMS-Unit; each number is separated with an ampersand "&", e.g. 1&2&3&4.
Send eMail	You can enter up to four e-mail addresses that you have entered previously from Setup – eMail (SMTP); each address is separated with an ampersand "&", e.g. 1&2&3&4.
Combinations	Configure the switching combi-

7 Operation

EN

	nations (see 7.7.14 Configuring switching combinations for the digital relay output module).
Switch Output	Manual switch on (On) or switch off (Off).
Accept	Accept the changes.
Reset	Reset all settings to the last-saved values; changes are not accepted.

7.7.14 Configuring the switching combinations for the digital relay output module

The switching combination for the digital relay output module (DK 7320.590) is configured as follows: Various switching combinations can be set.

Navigation	
Main menu – Setup – Click sensor name – Switching combinations	
Parameter	Explanation
If status of	Select the first sensor for the switching combination.
is	Select the first sensor state for a switching operation.
and/or	Select an "and" or "or" operation
status of	Select the second sensor for the switching combination.
is	Select the second sensor state for a switching operation.
Then.....output	Select the switching state when the switching combination is satisfied. Switch off = disable relay output; switch on = enable relay output.
Accept	Accept the changes.
Reset	Reset all settings to the last-saved values; changes are not accepted.

7.7.15

Configuring the voltage monitor

The voltage monitor (DK 7320.600) is configured as follows: Only the status of the sensor is specified.

Navigation	
Main menu – Setup – Click sensor name	
Parameter	Explanation
1 ... n	Connection number of the sensor.
Type	Sensor type. Will be detected automatically.
Sensor Status	Input state and sensor status. Green = OK, red = alarm
Message Text	Message text also transferred when an alarm message is sent. Enter here a designation that uniquely identifies your sensor, e.g. "Volt.Rack01".
Relay Alarm	Whether (enable) or not (disable) an alarm should switch an alarm relay.
Beeper Alarm	Whether (enable) or not (disable) an alarm should cause a signal to be issued.
Reset Alarm	Whether or not an alarm should be acknowledged automatically (Auto) or must be acknowledged by the administrator (Manual).
Trap Receiver	Set to which of the entered trap receivers the alarm messages should be sent. Enter the trap receivers at 7.3.2 Configuring the trap receiver.
Scheduled Alarm Off	Set which alarm configuration should be enabled or disabled. The individual functions can be specified from the "Setup – Timer" menu item.
Send SMS	You can enter up to four mobile telephone numbers that you have entered previously from Setup – SMS-Unit; each number is separated with an ampersand "&", e.g. 1&2&3&4.
Send eMail	You can enter up to four e-mail addresses that you have entered previously from Setup – eMail (SMTP); each address is separated with an ampersand "&", e.g. 1&2&3&4.
Accept	Accept the changes.

Reset	Reset all settings to the last-saved values; changes are not accepted.
-------	--

Scheduled Alarm Off	Set which alarm configuration should be enabled or disabled. The individual functions can be specified from the "Setup – Timer" menu item.
Send SMS	You can enter up to four mobile telephone numbers that you have entered previously from Setup – SMS-Unit; each number is separated with an ampersand "&", e.g. 1&2&3&4.
Send eMail	You can enter up to four e-mail addresses that you have entered previously from Setup – eMail (SMTP); each address is separated with an ampersand "&", e.g. 1&2&3&4.
Accept	Accept the changes.
Reset	Reset all settings to the last-saved values; changes are not accepted.

7.7.16 Configuring the voltage monitoring for the voltage monitor with IEC switching output

The voltage monitor with IEC switching output (DK 7320.610) is configured as follows: The individual values are specified in volts.

Navigation	
Main menu – Setup – Click sensor name	
Parameter	Explanation
1 ... n	Connection number of the sensor.
Type	Sensor type. Will be detected automatically.
Sensor Status	Measured voltage and sensor status. Green = OK, red = alarm
Message Text	Message text also transferred when an alarm message is sent. Enter here a designation that uniquely identifies your sensor, e.g. "Volt.Rack01".
High Setpoint	Voltage limit which when exceeded causes an alarm message to be issued.
Warning Setpoint	Voltage limit which when exceeded causes a warning message to be issued.
Low Setpoint	Voltage limit which when undershot causes an alarm message to be issued.
Relay Alarm	Whether (enable) or not (disable) a warning/alarm should switch an alarm relay.
Beeper Alarm	Whether (enable) or not (disable) a warning/alarm should cause a signal to be issued.
Reset Alarm	Whether or not an alarm should be acknowledged automatically (Auto) or must be acknowledged by the administrator (Manual).
Trap Receiver	Set to which of the entered trap receivers the alarm messages should be sent. Enter the trap receivers at 7.3.2 Configuring the trap receiver.

7.7.17 Configuring the switching output for the voltage monitor with IEC switching output

The switching output for the voltage monitor with IEC switching output (DK 7320.610) is configured as follows: Only the status of the sensor is specified.

Navigation	
Main menu – Setup – Click sensor name	
Parameter	Explanation
1 ... n	Connection number of the sensor.
Type	Sensor type. Will be detected automatically.
Output Status	Relay output status; enabled = on, disabled = off
Message Text	Message text also transferred when an alarm message is sent. Enter here a designation that uniquely identifies your sensor, e.g. "Volt.Rack01".
Delay	Delay time before switching on or off again. 0 s = no initiation time; 999 s = 999 seconds initiation time.
Timeout	Module behaviour in case of failure of the Basic CMC provided the module itself is still supplied with power: stay = after expiration of the

7 Operation

EN

	time, return to the original state; switch off = after expiration of the time, the output will be switched off; switch on = after expiration of the time, the relay will be switched on.
Trap Receiver	Set to which of the entered trap receivers the status messages should be sent. Enter the trap receivers at 7.3.2 Configuring the trap receiver.
Send SMS	You can enter up to four mobile telephone numbers that you have entered previously from Setup – SMS-Unit; each number is separated with an ampersand "&", e.g. 1&2&3&4.
Send eMail	You can enter up to four e-mail addresses that you have entered previously from Setup – eMail (SMTP); each address is separated with an ampersand "&", e.g. 1&2&3&4.
Combinations	Configure the switching combinations (see 7.7.18 Configuring switching combinations for the voltage monitor with IEC switching output).
Switch Output	Manual switch on (On) or switch off (Off).
Accept	Accept the changes.
Reset	Reset all settings to the last-saved values; changes are not accepted.

7.7.18 Configuring the switching combinations for the voltage monitor with IEC switching output

The switching combination for the voltage monitor with IEC switching output (DK 7320.610) is configured as follows: Various switching combinations can be set.

Navigation	
Main menu – Setup – Click sensor name – Switching combinations	
Parameter	Explanation
If status of	Select the first sensor for the switching combination.
is	Select the first sensor state for a switching operation.

and/or	Select an "and" or "or" operation
status of	Select the second sensor for the switching combination.
is	Select the second sensor state for a switching operation.
Then.....output	Select the switching state when the switching combination is satisfied. switch off = disable switching output; switch on = enable switching output.
Accept	Accept the changes.
Reset	Reset all settings to the last-saved values; changes are not accepted.

7.7.19 Configuring the voltage monitoring for the voltage monitor with 16 A switching output

The voltage monitor with 16 A switching output (DK 7320.611) is configured as follows: The individual values are specified in volts.

Navigation	
Main menu – Setup – Click sensor name	
Parameter	Explanation
1 ... n	Connection number of the sensor.
Type	Sensor type. Will be detected automatically.
Sensor Status	Measured voltage and sensor status. Green = OK, yellow = warning, red = alarm
Message Text	Message text also transferred when a warning/alarm message is sent. Enter here a designation that uniquely identifies your sensor, e.g. "Volt.Rack01".
High Setpoint	Voltage limit which when exceeded causes an alarm message to be issued.
Warning Setpoint	Voltage limit which when exceeded causes a warning message to be issued.
Low Setpoint	Voltage limit which when undershot causes an alarm message to be issued.
Relay Alarm	Whether (enable) or not (disable) a warning/alarm should switch an alarm relay.

Beeper Alarm	Whether (enable) or not (disable) a warning/alarm should cause a signal to be issued.
Reset Alarm	Whether or not a warning/alarm should be acknowledged automatically (Auto) or must be acknowledged by the administrator (Manual).
Trap Receiver	Set to which of the entered trap receivers the warning/alarm messages should be sent. Enter the trap receivers at 7.3.2 Configuring the trap receiver.
Scheduled Alarm Off	Set which alarm configuration should be enabled or disabled. The individual functions can be specified from the "Setup – Timer" menu item.
Send SMS	You can enter up to four mobile telephone numbers that you have entered previously from Setup – SMS-Unit; each number is separated with an ampersand "&", e.g. 1&2&3&4.
Send eMail	You can enter up to four e-mail addresses that you have entered previously from Setup – eMail (SMTP); each address is separated with an ampersand "&", e.g. 1&2&3&4.
Accept	Accept the changes.
Reset	Reset all settings to the last-saved values; changes are not accepted.

7.7.20 Configuring the switching output for the voltage monitor with 16 A switching output

The switching output for the voltage monitor with 16 A switching output (DK 7320.611) is configured as follows: Only the status of the sensor is specified.

Navigation	
Main menu – Setup – Click sensor name	
Parameter	Explanation
1 ... n	Connection number of the sensor.
Type	Sensor type. Will be detected automatically.
Output Status	Relay output status; enabled = on, disabled = off.

Message Text	Message text also transferred when a status message is sent. Enter here a designation that uniquely identifies your sensor, e.g. "Volt.Rack01".
Delay	Delay time before switching on or off again. 0 s = no initiation time; 999 s = 999 seconds initiation time.
Timeout	Module behaviour in case of failure of the Basic CMC provided the module itself is still supplied with power: stay = after expiration of the time, return to the original state; switch off = after expiration of the time, the output will be switched off; switch on = after expiration of the time, the relay will be switched on.
Trap Receiver	Set at which of the entered trap receivers, the status messages should be sent. Enter the trap receivers at 7.3.2 Configuring the trap receiver.
Send SMS	You can enter up to four mobile telephone numbers that you have entered previously from Setup – SMS-Unit; each number is separated with an ampersand "&", e.g. 1&2&3&4.
Send eMail	You can enter up to four e-mail addresses that you have entered previously from Setup – eMail (SMTP); each address is separated with an ampersand "&", e.g. 1&2&3&4.
Combinations	Configure the switching combinations (see 7.7.21 Configuring switching combinations for the voltage monitor with 16 A switching output).
Switch Output	Manual switch on (On) or switch off (Off).
Accept	Accept the changes.
Reset	Reset all settings to the last-saved values; changes are not accepted.

7 Operation

EN

7.7.21 Configuring the switching combinations for the voltage monitor with 16 A switching output

The switching combination for the voltage monitor with 16 A switching output (DK 7320.611) is configured as follows: Various switching combinations can be set.

Navigation	
Main menu – Setup – Click sensor name – Switching combinations	
Parameter	Explanation
If status of	Select the first sensor for the switching combination.
is	Select the first sensor state for a switching operation.
and/or	Select an "and" or "or" operation.
status of	Select the second sensor for the switching combination.
is	Select the second sensor state for a switching operation.
Then.....output	Select the switching state when the switching combination is satisfied. switch off = disable switching output; switch on = enable switching output.
Accept	Accept the changes.
Reset	Reset all settings to the last-saved values; changes are not accepted.

7.7.22 Configuring the 48 V voltage monitor

The 48 V voltage monitor (DK 7320.620) is configured as follows: Only the status of the sensor is specified.

Navigation	
Main menu – Setup – Click sensor name	
Parameter	Explanation
1 ... n	Connection number of the sensor.
Type	Sensor type. Will detected automatically.
Sensor Status	48 V voltage monitor state and sensor status. Green = OK, red = alarm.
Message Text	Message text also transferred when a warning/alarm message

	is sent. Enter here a designation that uniquely identifies your sensor, e.g. "48 V Volt. Rack01".
Relay Alarm	Whether (enable) or not (disable) an alarm should switch an alarm relay.
Beeper Alarm	Whether (enable) or not (disable) an alarm should cause a signal to be issued.
Reset Alarm	Whether or not an alarm should be acknowledged automatically (Auto) or must be acknowledged by the administrator (Manual).
Trap Receiver	Set to which of the entered trap receivers the alarm messages should be sent. Enter the trap receivers at 7.3.2 Configuring the trap receiver.
Scheduled Alarm Off	Set which alarm configuration should be enabled or disabled. The individual functions can be specified from the "Setup – Timer" menu item.
Send SMS	You can enter up to four mobile telephone numbers that you have entered previously from Setup – SMS-Unit; each number is separated with an ampersand "&", e.g. 1&2&3&4.
Send eMail	You can enter up to four e-mail addresses that you have entered previously from Setup – eMail (SMTP); each address is separated with an ampersand "&", e.g. 1&2&3&4.
Accept	Accept the changes.
Reset	Reset all settings to the last-saved values; changes are not accepted.

7.7.23 Configuring the leak sensor

The leak sensor (DK 7320.630) is configured as follows: Only the status of the sensor is specified.

Navigation	
Main menu – Setup – Click sensor name	
Parameter	Explanation
1 ... n	Connection number of the sensor.
Type	Sensor type. Will be detected

	automatically.
Sensor Status	Leak sensor state and sensor status. Green = OK, red = alarm.
Message Text	Message text also transferred when an alarm message is sent. Enter here a designation that uniquely identifies your sensor, e.g. "Leak Rack01".
Relay Alarm	Whether (enable) or not (disable) an alarm should switch an alarm relay.
Beeper Alarm	Whether (enable) or not (disable) an alarm should cause a signal to be issued.
Reset Alarm	Whether or not an alarm should be acknowledged automatically (Auto) or must be acknowledged by the administrator (Manual).
Trap Receiver	Set to which of the entered trap receivers the alarm messages should be sent. Enter the trap receivers at 7.3.2 Configuring the trap receiver.
Scheduled Alarm Off	Set which alarm configuration should be enabled or disabled. The individual functions can be specified from the "Setup – Timer" menu item.
Send SMS	You can enter up to four mobile telephone numbers that you have entered previously from Setup – SMS-Unit; each number is separated with an ampersand "&", e.g. 1&2&3&4.
Send eMail	You can enter up to four e-mail addresses that you have entered previously from Setup – eMail (SMTP); each address is separated with an ampersand "&", e.g. 1&2&3&4.
Accept	Accept the changes.
Reset	Reset all settings to the last-saved values; changes are not accepted.

7.7.24

Configuring the acoustic sensor

The acoustic sensor (DK 7320.640) is configured as follows: Various limit values can be specified as percentage.

Navigation	
Main menu – Setup – Click sensor name	
Parameter	Explanation
1 ... n	Connection number of the sensor.
Type	Sensor type. Will be detected automatically.
Sensor Status	Measured noise level as percentage and sensor status. Green = OK, yellow = warning, red = alarm
Message Text	Message text also transferred when a warning/alarm message is sent. Enter here a designation that uniquely identifies your sensor, e.g. "Acoustic Rack01".
High Setpoint	Noise level limit as percentage which when exceeded causes an alarm message to be issued.
Warning Setpoint	Noise level limit as percentage which when exceeded causes a warning message to be issued.
Low Setpoint	Noise level limit as percentage which when undershot causes an alarm message to be issued.
Relay Alarm	Whether (enable) or not (disable) a warning/alarm should switch an alarm relay.
Beeper Alarm	Whether (enable) or not (disable) a warning/alarm should cause a signal to be issued.
Reset Alarm	Whether or not a warning/alarm should be acknowledged automatically (Auto) or must be acknowledged by the administrator (Manual).
Trap Receiver	Set to which of the entered trap receivers the warning/alarm messages should be sent. Enter the trap receivers at 7.3.2 Configuring the trap receiver.
Scheduled Alarm Off	Set which alarm configuration should be enabled or disabled. The individual functions can be specified from the "Setup – Timer" menu item.
Send SMS	You can enter up to four mobile telephone numbers that you

7 Operation

	have entered previously from Setup – SMS-Unit; each number is separated with an ampersand "&", e.g. 1&2&3&4.
Send eMail	You can enter up to four e-mail addresses that you have entered previously from Setup – eMail (SMTP); each address is separated with an ampersand "&", e.g. 1&2&3&4.
Accept	Accept the changes.
Reset	Reset all settings to the last-saved values; changes are not accepted.

7.8 Access using Telnet

You can also configure the Basic CMCs using Telnet. This requires that you are permitted to have access with the terminal program using Telnet (see 7.3.18 Configuring Telnet access).

7.8.1 Login using Telnet

This section describes access using Telnet with Windows.

- Open the command prompt and enter the following command:
telnet <IP-address>
- Press "Return" or "Enter" to confirm.
- Enter for "login" the Telnet login (factory setting: `cmc`). Press "Return" or "Enter" to confirm.
- Enter for "Password" the Telnet password (factory setting: `cmc`). Press "Return" or "Enter" to confirm.

7.8.2 Telnet main menu

After login using Telnet, the same main menu as for access using Hyperterminal appears. Because the procedure is similar, consult Section 7.1.



Note!
In addition to access using Telnet, an encrypted access to the Basic CMC configuration using an SSH client (e.g. Putty) is possible. In contrast to Telnet access, the SSH access cannot be disabled.

7.9

Perform a software update.

Download from the www.rimatrix5.com (Security) internet page in the download area, the software update for the Basic CMC to your PC. Unpack the file into a separate folder, e.g. with the name: basicupdate



Note!
The update takes approximately ten minutes.
Also refer to the update guidelines that the update makes available for download in the internet.



Caution!
The update must not be interrupted, because otherwise a complete failure of the Basic CMC can result.

- Open the command prompt and navigate to the folder that contains the unpacked software update.
- Enter the following command: update <IP-address> (e.g. update 192.168.0.130).

The Basic CMC must be reachable in the network using the entered IP address.

The file will now be sent to the Basic CMC. This is displayed with several #-characters in the command prompt window.

The Basic CMC automatically performs two restarts during the update process. The process takes several minutes. Do not change anything on the CMC-TC. Do not disconnect the Basic CMC from the mains. Wait until the Operation LED illuminates again and the message described in the Update guide appears.

7.10 Error messages

Operation/Alarm LED off

Cause	Rectification
Power pack not connected	Connect power pack.
Power pack defective	Replace the defective power pack with an operational one.
Missing power supply	Establish the power supply.
Basic CMC booting	Wait several minutes until the LED illuminates.

Link/Traffic LED off

Cause	Rectification
Network connection missing	Connect RJ-45 network cable.
Incorrect IP address	Check the IP address.
Incorrect subnet mask	Check the subnet mask.
Incorrect gateway address	Check the gateway address.

No access authorisation using Telnet

Cause	Rectification
Telnet access blocked for the Basic CMC	Activate Telnet access using Hyperterminal.
Incorrect IP address entered	Check the IP address.
Incorrect user-name entered	Check the username.
Incorrect password entered	Check the password.

No access authorisation using the browser

Cause	Rectification
Incorrect user-name entered	Check the username.
Incorrect password entered	Check the password.

No access authorisation using Hyperterminal

Cause	Rectification
Incorrect user-name entered	Check the username.
Incorrect password entered	Check the password.

No setting capability using the browser

Cause	Rectification
Web access set only to read authorisation	Set the access authorisation using Hyperterminal or Telnet in the Web access menu item. Alternatively, the administrator must set the appropriate rights for the user in the web interface.

SNMP does not send (or traps do not arrive)

Cause	Rectification
The read and write community entries are not set correctly	Use Hyperterminal or Telnet to compare the read and write authorisation with that of the management software.
Trap receivers have not been entered	Check the trap receivers.

Sensor not detected or not displayed

Cause	Rectification
Sensor not contained in the software	Perform a software update.
Sensor defect	Replace sensor.
Sensor not connected	Connect sensor; possibly remove and reinsert the sensor several times. In seldom cases, it can help short-term to insert another sensor and then change back to the first sensor.

7.11 Structural layout of the MIB of the Basic CMC

Only the device-typical part of the MIB of the Basic CMC (CMC-TC.MIB) is described briefly here. This area of the MIB, in particular, must take account of the system concept of the CMC-TC system. For this reason, the related information that applies to the sensors/actuators and the CMC 7200.520 expansion unit is shown, mainly in table structure.

Depending on the sensor / CMC 7320.520 expansion unit, a table for the sensors, the outputs/actuators and the messages is provided. A maximum of four sensors and two CMC extension units (7320.520) can be connected to the Basic CMC.

The number of table rows differs depending on the table type and depends on the maximum number of sensor unit ports that can be assigned.

Note that the number of possible sensors, outputs and messages is stored in a dedicated MIB variable.

7 Operation

EN

Sensors:

Instance	unit...	unit2SensorType	unit2SensorText	unit2SensorStatus	unit2SensorVal
1	1	notAvail(1)	not available	notAvail(1)	0
2	2	temperature(10)	Temperature Sensor	ok(4)	26
3	3	vibration(5)	Vandalism Sensor	ok(4)	0
4	4	humidity(12)	Humidity Sensor	ok(4)	59



Note!

The numbers in column 2 correspond to the port numbers of the Basic CMC sensor port. The sensors are assigned in accordance with their physical connection. Outputs are not displayed in this table, refer to the following table.

Outputs:

Instance	u...	unit2OutputType	unit2OutputText	unit2OutputStatus	unit2OutputValue	unit2O
1	1	universalOut(9)	Digital Output	off(5)	0	off(1)
2	2	notAvail(1)	not available	notAvail(1)	0	off(1)
3	3	notAvail(1)	not available	notAvail(1)	0	off(1)
4	4	notAvail(1)	not available	notAvail(1)	0	off(1)



Note!

The numbers in column 2 correspond to the port numbers of the Basic CMC sensor port. The displayed outputs correspond to their physical connection on the port.

Messages:

Instance	u...	unit2MsgText	unit2MsgStatus	unit2MsgRelay	unit2MsgB
1	1	Digital Output	setOff(9)	enable(2)	enable(2)
2	2	Temperature Sensor	ok(4)	enable(2)	enable(2)
3	3	Vandalism Sensor	ok(4)	enable(2)	enable(2)
4	4	Humidity Sensor	ok(4)	enable(2)	enable(2)



Note!

The numbers in column 2 correspond to the port numbers of the Basic CMC sensor port. The displayed table entries correspond to the current status and the configuration settings for the port.

Representation of the general setup table and sample table entries

Another table shows the general setup settings shown below.

Name	Syntax	Value
cmcTcSetTempUnit.0	int32	celsius(1)
cmcTcSetBeeper.0	int32	off(1)
cmcTcQuitRelay.0	int32	disabled(1)
cmcTcLogicRelay.0	int32	closeAtAlarm(1)
cmcTcWebAccess.0	int32	fullAccess(2)
cmcTcSetupDate.0	octets	19.09.2002
cmcTcSetupTime.0	octets	15:18:14

7.12 Saving and transferring the configuration files

This function can be used to save the Basic CMC configuration and, if necessary, restore it on the system later.

The configuration can also be transferred to other Basic CMCs that are wired and structured identically.



Note!

This function may be used only when the Basic CMCs are identical with regard to:

- Sensor types and the used ports
- Sensor units, and the used ports and addresses
- Software versions

No sensors / sensor units may be missing or connected in a different order.

If this restriction is not observed, the Basic CMC system will not accept the configuration.

Saving configuration files:

When the commissioning, installation and the setting of all text, limit values, links, network setting, etc., has been completed, this information will be saved on an external system (network PC).

The FTP or SFTP protocol can be used to establish an access to the **Download** directory in the Basic CMC.

The three files can be loaded there and saved on the network PC.

- cmc.cfg (not editable) system data
- cmc.user (not editable) data of the user administration
- net.cfg (editable) network settings

The changes are accepted immediately after the file has been transferred. The correctness of the acceptance can be seen in the event log.



Note!

When the net.cfg file is edited, under no circumstances may the format or the file structure be changed. The non-observance can cause a complete system failure.

Transferring configuration files:

Prerequisite -> The three configuration files have been saved previously.

The FTP or SFTP protocol can be used to establish an access to the **Upload** directory in the Basic CMC.

The following configuration files are transferred to the target device:

cmc.cfg	(not editable) installation data
cmc.user	(not editable) data of the user administration
net.cfg	(editable) network settings

8 Maintenance and cleaning

The Rittal Basic CMC does not require any maintenance. The housing does not need to be opened during the installation or during operation.



Note!

Opening the housing or the accessory components voids any warranty or liability claims.

8.1.1 Cleaning



Caution!

Danger of damage!
Do not use any aggressive materials, such as white spirits, acid, etc., for cleaning because they can damage the device.

Use a lightly dampened cloth for cleaning the housing.

9 Storage and disposal

9.1.1 Storage

If the device is not being used over a longer period, we recommend that it be removed from the power supply and protected from humidity and dust.

Further information concerning the operating conditions is contained in the technical specifications.

9.1.2 Disposal

Because the Basic CMC consists mainly of the housing and circuit board components, the device should be sent for disposal to the electronic recycling when it is no longer required.

10 Customer service

Should you have any questions (either technical or general) concerning our product spectrum, please contact the following service address:

Tel.: +49 (0)2772/505-1855
<http://www.rimatrix5.com>
E-mail: info@rittal.de



Note!

To allow us to process your request quickly and correctly, please always specify the article number in the subject line for e-mails.

Further information and the current operating guides and updates of the Rittal CMC-TC can be downloaded from Security on the Rimatrix5 home page.

11 Technical specifications

EN

11 Technical specifications

Description	Basic CMC
Housing	
Housing type	Plastic covering with metal trim plate
Height	1 U / 44.5 mm
Width	136 mm
Depth	129 mm
Weight without packing	approx. 0.6 kg
Potential equalisation	- ¹⁾
Earthing	- ¹⁾
Protection category	IP 40 in accordance with EN 60529
Interfaces	
Keys	1 foil key, confirm key
Front socket	1 x RJ-10 socket (RS 232 serial interface)
LED display	2 x (active/alarm)
Acoustical indicator	1 x piezo signal transducer
I ² C connection	RJ-45 socket (P-I ² C), shielded
Alarm relay	
Output	1 x RJ-12 socket, shielded
Design	Potential-free changeover contact
Rated voltage	24 V DC, internal or 24 V for external voltage interconnection
Current	200 mA
Operating range	
Temperature	+5° to +45° C +42° to +113° F
Humidity	5 – 95 %
Storage temp.	-20° to +60° C -4° to +140° F
Rated voltage	1 x 24 V DC, 2.5 A SELV
Fuses	Fine fuse T2A, 250 V, UL approval
Network	1 x RJ-45 socket (Ethernet, 10/100 BaseT), shielded
Sensor island	4 x RJ12 socket, sensors and the RJ12 sensor cable

Maximum cable length	
Basic CMC to the sensor	2 m, after consultation with Rittal, up to 22 m with 4 x 7200.450 extensions
Protocols	
Available protocols	<ul style="list-style-type: none"> - TCP/IP - SNMP V1.0 (incl. MIB II) - SNMPv3 - TELNET, SSH - FTP, SFTP - http, https, SSL 3.0 - NTP - DHCP - SMTP

Technical specifications

¹⁾ Not required, because 24°V DC safety extra-low voltage

12 Technical terms

CMC-TC

CMC-TC (Computer Multi Control - Top Concept) is a Rittal product used to monitor network enclosure components.

GSM card

A GSM card is a telephone card of a mobile telephone.

Internet browser

An internet browser can be used to display html pages (and those that conform to a similar standard). In case of the Basic CMC, such pages can be configured with a user interface displayed with an internet browser.

Link

A link is a branch to another internet page or establishes a connection between two internet pages.

MAC address

The MAC address is a letter and number combination of a network interface that is unique worldwide. This is used to identify a network interface in a network, etc.

MIB (Management Information Base)

The MIB was developed to fetch and change network elements. The MIB II has been defined in the RFC 1213. Some manufacturers define their own MIBs that reflect the special characteristics of their product. The MIBs are registered as OID with the IANA (Internet Assigned Numbers Authority). Once an object has been assigned to an OID, the mean-

ing may no longer be changed. An overlapping with other OIDs is not permitted.

SMS service no.

This a telephone number that the telephone provider makes available for sending SMSes.

SNMP (Simple Network Management Protocol)

The SNMP is a simple network management protocol based on TCP/IP. It was developed to allow network components to be monitored at a central management station.

Telnet

Telnet is a protocol to allow guest access to a remote server. The Telnet program provides the required client functions of the protocol.

Trap

Trap is the sending of SNMP messages.

Trap Receiver

The trap receiver is the recipient of SNMP messages.

Web access

The web access specifies the access capability using the internet.

13 Declaration of conformity

EN

13 Declaration of conformity

Konformitätserklärung

Declaration of Conformity

Reg. Nr.: 5 232 302 - 1



Wir

We

Rittal

GmbH & Co. KG

Postfach 16 62

35726 Herborn

Germany

erklären, dass das Produkt
declare that the product

CMC-TC - Schranküberwachung
Rack-Monitoring and Control

CMC-TC

DK 7320.100 CMC-TC Prozessor Unit (PU)

DK 7320.111 BasicCMC

DK 7320.210 CMC-TC Sensoreinheit I/O Unit (IOU)

DK 7320.220 CMC-TC Sensoreinheit Access Unit (AU)

DK 7320.230 CMC-TC Sensoreinheit Climate Unit (CU)

mit der/den folgenden Norm(en) oder Normativen Dokument(en) übereinstimmt.

is in conformity with the following standard(s) or other normative document(s)

EN 60950-1 Ausgabe 2003/03

EN 55022 Ausgabe 2003/09

EN 61000-3-2 Ausgabe 2006/10

EN 61000-3-3 Ausgabe 2006/06

EN 61000-6-2 Ausgabe 2006/03

EN 61000-6-3 Ausgabe 2005/06

Gemäß den Bestimmungen der Richtlinie(n)

Following the provisions of Directive(s)

Niederspannungsrichtlinie Nr.: 73/23/EWG und Änderungen

Low Voltage Directive

EMV - Richtlinie

EMC Directive

Nr.: 89/336/EWG

und Änderungen

and updates

Herborn, 28 Dezember 04

Jahr der ersten Kennzeichnung: 2002
Year of first marking.

W. Schmid / Geschäftsführer
W. Schmid / Executive Vice President

Diese Konformitätserklärung entspricht der Europäischen Norm EN 45014 "Allgemeine Kriterien für Konformitätserklärungen von Anbietern"
This declaration of conformity is suitable to the European Standard EN 45014 "General criteria for suppliers declaration of conformity"

NWGQ7

October 23, 2003

Information Technology Equipment Including Electrical Business Equipment Certified for Canada

RITTAL GMBH & CO KG

AUF DEM STUETZELBERG, 35745 HERBORN GERMANY

E215843

Computer multi control units - Top concept, Model(s) CMC - TC AU, CMC - TC CU, CMC - TC IO, CMC - TC PU.

LOOK FOR LISTING MARK ON PRODUCT

NWGQ

October 23, 2003

Information Technology Equipment Including Electrical Business Equipment

RITTAL GMBH & CO KG

AUF DEM STUETZELBERG, 35745 HERBORN GERMANY

E215843

Computer multi control units - Top concept.

Computer multi control units - Top concept, Model(s) CMC - TC AU, CMC - TC CU, CMC - TC IO, CMC - TC PU.

LOOK FOR LISTING MARK ON PRODUCT

